

Owner Instructions

Original Instructions
Warning! Read instructions before using the machine



CleanTec
NHL 15



www.numatic.com



Cleaning tips

Good carpet cleaning is very much a team effort between operative and machine and a few well established rules to be followed to get the best results.

1.	Move furniture.
2.	Vacuum thoroughly.
3.	Test carpet for colour fastness (out of sight).
4.	Spot clean as necessary.
5.	Open window for ventilation.
6.	Always use a low foaming carpet cleaner.
7.	Always work backwards towards the Exit Door.
8.	Clean full carpet area - Hi pump setting for heavy soiling and Lo pump setting for lightly soiled areas.
9.	Do not overwet remember 'What goes in, must come out again!'
10.	Leave windows open to help carpet dry naturally.



Product Features

- * TriJet carpet extraction head.
- * Lo pressure for lightly soiled areas.
- * Hi pressure for heavy soiled areas.
- * Quality upholstery tool supplied.
- * Dump hose emptying option.
- * 4 wheel mobility.
- * 15 litres capacity.
- * Full Aluminium tool head.



The Hi - Lo system puts you in complete control, when you need more, you get more and when you need less, you are but a switch away.

Contents / Kits - B26 - BS27





Before continuing, please refer to Quick Set Up Guide on Page 8



Cleaning Tips / Kit B26 - BS27	Page 2
Index	Page 3
Quick Set Up Guide	Page 4
Machine Overview	Page 5
Rating Label / PPE / Critical components / Specifications	Page 6
Information for wet machines	Page 7
Fault finding	Page 8

Machine Set up.

Fitting the handle	Page 9
Removing the dome and waste water tank	Page 10
Filling the Nuchem / water tank	Page 10
Chemical usage	Page 11
Replacing waste water tank and the dome	Page 12
Fitting vacuum hose	Page 12
Connecting solution tube	Page 12
Assembling wands and floor tool	Page 13

Operating the machine

Controls and switches	Page 14
Correct way to use the machine	Page 14
Using the hand tool	Page 15

Cleaning the machine

Emptying the waste water	Page 16
Removing the wands and floor tool	Page 16
Cleaning the Tanks and filters	Page 16
Blocked Nozzles	Page 17

Maintenance

Maintenance	Page 18
Replacing the vacuum filter	Page 18
Replacing vacuum or pump fuses	Page 18
Changing the cable	Page 19
Troubleshooting	Page 20
Recommended spare parts	Page 20
Technical helpline	Page 20
Wiring Diagram	Page 21

Documentation

Warranty	Page 22
Declaration Documents	Page 23
Company Addresses	Page 24

Quick Set Up Guide

PLEASE READ BEFORE COMMENCING ANY OPERATION
After the removal of all the packaging, carefully open and check the contents.



Fit the handle to the machine using the fixings supplied. (Fig 1)



Remove the dome, unclip and remove the waste water tank (Fig 2)



Fill the NuChem / water tank, up to the full level mark, avoid pouring fluids into the central tube as this leads directly to the vacuum motor (Fig 3).



Replace the waste water tank, lock in place using the red locking clamp and replace the dome. (Fig 4)



Assemble the wands and floor-tool and hose and secure to the machine (Fig 5)



Connect the solution tube (Fig 6)



The switches on the front of the machine, control the vacuum and pump operations. (Fig 7)
See page 15 for cleaning controls.

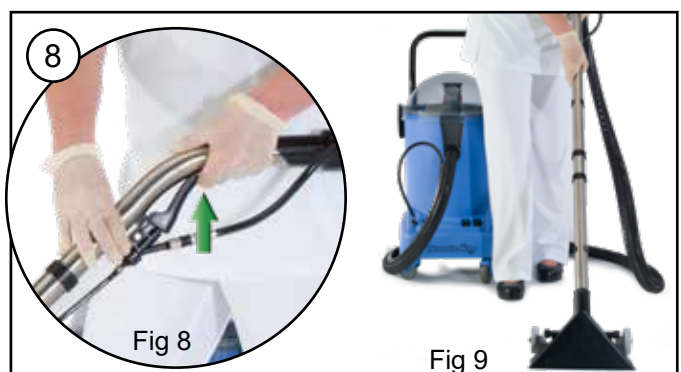

Operate the trigger (Fig 8) to apply water and vacuum the carpet (Fig 9).

Machine Overview





1. Plugged Cable cover
2. 6.3 amp time lag fuse x 2.
3. Plugged cable
4. Cable grommet
5. Vacuum filter cover
6. Vacuum filter
7. Castor wheels x 4
8. Quick release
9. Hi Lo Pump Switch
10. Vacuum Switch
11. Pump Switch
12. Dome
13. Waste tank locking toggle
14. Waste tank vacuum filter
15. Waste tank emptying hose
16. Handle
17. Cable strain relief
18. Solution tube quick release

For full easy to follow
Instructions on
the NHL 15 set up and use,
See quick set up guide
page 4

Rating Label - WEEE - PPE - Safety Critical Components

About the machine

Numatic International Ltd. CHARD, ENGLAND TA20 2GB	Company name and address
NHL 15	Machine Description
220- 240v~ 50-60Hz	Voltage / Frequency
1200W MAX 1000W IEC	Power Rating
35Kgs	Weight (Ready to use)
	WEEE Logo
	CE Mark
4 bar	Max Pressure
MAX 30° C	Max cleaning agent temp
IPX4	IPX Rating
 101229482	Yr / Wk / Serial Number

WEEE Legislation (Waste, Electrical and Electronic Equipment)

Vacuum cleaner, accessories and packaging should be sorted for environmental-friendly recycling.

Only for EU countries:
Do not dispose of Vacuum cleaner into household waste!
According to the European Directive 2002/96/EC on waste electrical and electronic equipment and its incorporation into national law.
Vacuum cleaners that are no longer suitable for use must be separately collected and sent for recovery in an environmental-friendly manner.



Safety Critical Components

- Mains Lead
HO5VV-F - 3 x 1.00mm - 10m
- 6.3 amp time lag Fuse

PPE
(personal protective equipment)
that may be required for certain operations.



NOTE:
A risk assessment should be conducted to determine which PPE should be worn.

Model	Motor	Airflow	Suction	Cleaning Range	Capacity Wet	Noise
NHL 15	1060W	49 L/sec	2400mm	26.8m	15 Litres	75.6 dB(A) uncertainty +/- 0.2 dB(A)
Pump	Solution Tank	Size H x W x D	Gross Weight (Full)	Specifications NHL 15		
2 Bar 30psi 4 Bar 60 psi	15 Litres	435 x 425 x 725 mm	35 Kgs			

Information for wet machines

Information for Spray Extraction Vacuum Cleaners

WARNING

Read the instruction manual before using the machine.

Operators shall be adequately instructed on the use of these machines.

As with all electrical equipment, care and attention must be exercised at all times during use, in addition to ensuring that routine and preventative maintenance is carried out periodically to ensure safe operation.

Failure to carry out maintenance as necessary, including the replacement of parts to the correct standard could render this equipment unsafe and the manufacturer can accept no responsibility in this respect.

The machine shall be disconnected from the mains by removing the plug from the supply socket during cleaning or maintenance and when replacing parts or converting the machine to another function.

The machine is not to be used by children or persons with reduced physical, sensory or mental capabilities, or lack of experience or knowledge, unless they have been given supervision or instruction.

Children being supervised are NOT to play with the machine.

This appliance is intended to be assembled, cleaned and maintained by an adult.

This machine is not a toy.

CAUTION!

If foam/liquid comes out of machine exhaust, switch off immediately.

Allow the accumulated liquid to drain out through the machine exhaust, check the waste water level, empty the waste water container if full.

Immediately upon start up there will be a certain amount of liquid issuing from the machine exhaust which will be the residue of liquid still within the power head. This will be quickly discharged after which the machine should function normally.

Liquid ejected from the machine could be hazardous as a result of its temperature, pressure or chemical content.

This machine is not suitable for the collection of biological hazards, hazardous or explosive dust. You should contact your local distributor if you require a machine capable of performing these tasks.

Ensure that the filtration system fitted to the machine is suitable for the material being collected.

This machine is for indoor use only.

This machine shall be stored indoors only

NOTE: This machine is also suitable for commercial use, for example in hotels, schools, hospitals, factories, shops, rental businesses and offices for other than normal housekeeping purposes.

This machine can be used for cleaning carpet and upholstery.

DO

- Dry Vacuum the carpet before using wet extraction cleaner.
- Turn off pump and operate the trigger, to release pressure in the dosing system, before removing spray tube.
- Keep your machine clean.
- Keep filters clean.
- Keep hoses and tubes clear.
- Replace any worn or damaged parts immediately.
- Regularly examine the power cord, if damage is found, power cord must be replaced by a qualified person Using the correct Numatic original part.
- Ensure that all components are assembled correctly before use.

DON'T

- Use steam cleaners or pressure washers to clean the machine or use the machine in the rain.
- Immerse in water for cleaning.
- Allow any inexperienced repairs. Call the experts.
- Use to suck up hot ashes, or lighted cigarette ends.
- Run the machine over the power cable during operation as a hazard may occur.
- Pull on the cable to unplug the machine from the power supply.
- Walk over-wet carpets, upholstery or fabrics.
- Walk on clean carpets until fully dry.
- Spray onto people or animals.
- Attempt machine maintenance or cleaning unless the power supply plug has been removed from the supply outlet.
- Do not use as a dry vacuum

Fault Finding - Wet - Spray Extraction

Spray extraction machines only

- Use only approved cleaning preparations.
- Use defoamer if necessary.

Use of detergents

When using any detergent with this machine, please ensure you have read the safety data on the container and you are familiar with the procedures to clear up spills, inhalation, skin and eye contact.

This product complies with the requirements IEC/EN 60335 -2-68.

When moving from one place to another, consider the weight of the machine.

Spray extraction maintenance/fault finding

If the vacuum cleaner stops working switch off and remove the plug from the wall, before investigating where the fault lies.

If the vacuum cleaner has a blockage and will not pick up liquid, switch off and remove the plug from the wall.

Remove the dome and empty the liquid out of the waster water container.

If the waster water container is empty, check that the floor tool wands and hose are not blocked.

If no spray from nozzle the solution tank is empty, refill the solution tank.

Flush the system with clean water after use.

If the machine stops spraying then check the clean water tank level, empty the waste water tank and refill the clean water tank as necessary.

If the spray nozzles are blocked, they have been designed to be easily cleaned. Undo the spray nozzle cap and clean the nozzles.

A pin maybe used to clear the blockage.

After use always inspect the machine for damage.

Caution.

**This machine has been designed to clean carpets and floors.
It must not be used when stood in water.**

Inspection schedule

Every time before use:-

Mains Cable.

Waste tank vacuum filter.

Hose, wands & tri jet assembly

Weekly

NuChem - water tank barrel filter (wash)

Vacuum filter (Check)

Visual inspection of Drum seal and bucket seal

Machine Set-Up

Fitting the handle



Fig 10

Slide the handle over the two tubes already fitted to the side of the machine. (Fig 10).



Fig 11

Secure the handle using the nut and bolt supplied (Fig 11).



Fig 12

The handle makes an ideal way to store the cable (Fig 12).



Fig 13

The handle can be used to enable the machine to be easily moved around the area to be cleaned (Fig 13).



Removing the dome and waste-water tank.



Fig 14

To remove the dome, unclip the locking toggles and lift the dome off the machine (Fig 14).

The waste water tank is held into place with a red locking clamp. Undo the clamp (Fig 15) and lift the waste water tank from the machine (Fig 16).



Fig 15



Fig 16

Filling the NuChem / water tank.

The NHL 15 is equipped with a large 15 litre NuChem / water tank allowing large areas to be cleaned in a single fill.

To fill the clean water tank remove the waste water tank and fill using hose, bucket or a suitable container (Fig 17).

Fill to the MAX level mark (Fig 18) located on the inside of the drum.

Ensure the clean water goes into the container and not the central tube.

Note.

Great care must be taken to ensure that contaminants (leaves, hair, dirt, etc) are not allowed to enter the NuChem / water tank during the filling process.

If using a bucket or similar container, ensure it is always clean and free from debris.

Caution:-

Avoid tipping water into the central tube this is leads directly to the vacuum motor (Fig 19).



Fig 17



Fig 18



Fig 19

Control of substances hazardous to health (COSHH)

For best results use a non-foaming type of chemical, dilute to the manufacturers specification.
 For further guidance on hazardous substances refer to HSE website.
 Visit <http://www.hse.gov.uk/> for UK information.



When handling and mixing chemicals.

Always ensure that chemical manufacturer's safety guidelines are followed.
 Only use non foaming chemicals when using this machine.



NuChem information

NuChem 4 available for this product.



INSTRUCTIONS FOR USE

TEST FOR COLOUR FASTNESS

Find a small area on the material which is not normally on view and test the carpet / fabric for colour fastness by rubbing the cloth dampened with correctly diluted NuChem 4.

FOR NORMAL SOILING:

Pour one 40ml measure into 5 litres of cold water.

FOR HEAVY SOILING:

Pour two 40 ml measures into 5 litres of cold water.

NuChem 4 is non-foaming, bactericidal, contains optical brighteners and leaves no tacky residues in the fabric and is enhanced with both a delicate and discreet verbena scent.

HEALTH AND SAFETY

Caution:

Keep out of the reach of children and pets.
 Wear suitable gloves.
 Avoid contact with skin and eyes.
 In case of eye contact flush with clean water seek medical attention.
 In case of contact with the skin rinse with plenty of clean water.
 Product data is available from Numatic.



INGREDIENTS

Composition:

Greater than 30% = Among other ingredients water

Less than 5% = Sodium Xylene Sulphonate

Classified as irritant

CAS: 1300 - 72 - 7

[Xi] R36 / 37 / 38

Risk Phrases: R36/38: irritating to eyes and skin

Safety Phrases: S2: Keep out of the reach of children

S24: Avoid contact with skin and eyes

S37: Wear suitable gloves for hand use



219847
 NuChem 500 mls

Replacing the waste-water tank and dome.

To replace the waste-water tank fit into the drum and lock in place with the red locking clip (Fig 20).

If the waste tank is not locked, the machine will lose performance.

Locate the handle into the front of the drum (Fig 21).

Refit the dome and lock in place with the toggles. (Fig 22)



Fitting the vacuum hose.



Fit the Vacuum hose to the front of the machine (Fig 23).

Lock into place by twisting the hose securing onto the lugs moulded into the neck of the machine.

Connecting the solution tube.

Fit the solution tube to the front of the machine (Fig 24).

The tube simply push fits into the quick release fitted to the front of the machine.



Assembling the wands and floor-tool

The NHL 15 comes with a complete set of high quality stainless steel wands.

To make the machine comfortable to use we have included a small spacer wand allowing the height of the wand set to be adjustable for different height operatives.

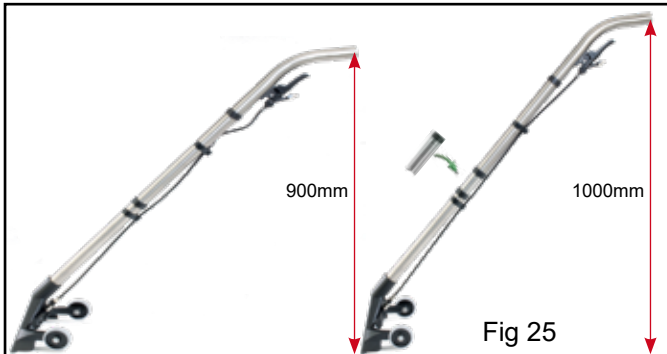

Assemble the wands, as shown.

Adjust the height using the small spacer wand to suit. (Fig 25).

Simply slide the wands together (Fig 26).

Ensure that the wands and floor tool are firmly located before use.

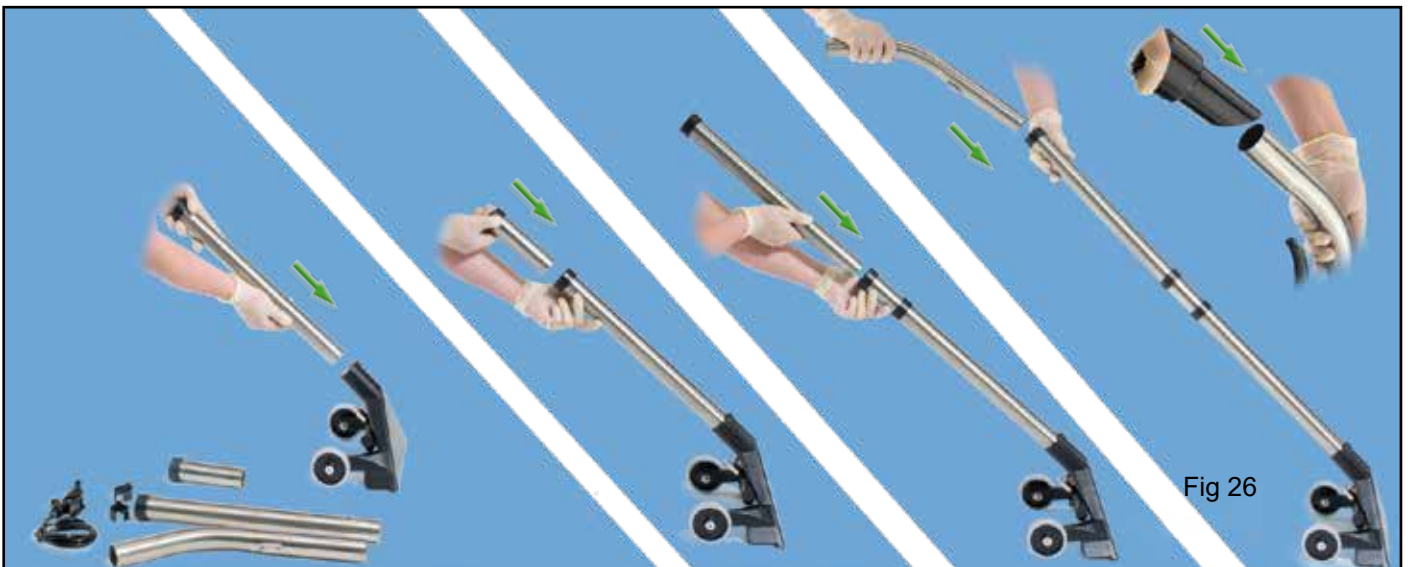

Connecting the solution tube



The solution tube has been designed so the trigger can be fitted either way on to the stainless curved wand. (fig 27)

Connect the solution tube from the hose on to the operating trigger (Fig 28).

Connect the solution tube end into the quick release connector fitted onto the floor-tool (Fig 29)
Clip the solution tube to the wand by using the clips supplied in the kit.

Adjust the working height by using the short wand spacer to allow comfortable use.

Operating the machine

Controls and Switches

All the switches on the NHL machine have been designed to enable easy use and they are placed on the front of the machine. These switches are to be operated by hand and NOT to be operated by foot.



On heavy soiled carpets you can double the pressure of the pump to 60 PSI by using the Hi / Lo switch (A)

To active the vacuum press 'vacuum switch' (B)

To activate the pump press 'pump switch' (C)

Note.

If machine not functioning correctly, see the Trouble-shooting guide Page 19

Correct way to use the machine



Fig 30

The NHL 15 floor-tool is provided with rear wheels allowing the floor-tool to glide over the surface to be cleaned (Fig 30).

Thus making the cleaning process less tiring and easier to use.

Apply a slight downward pressure on the wand lifting the floor-tool blade from the cleaning surface.

Move the floor-tool forward on the rear wheels (Fig 31).

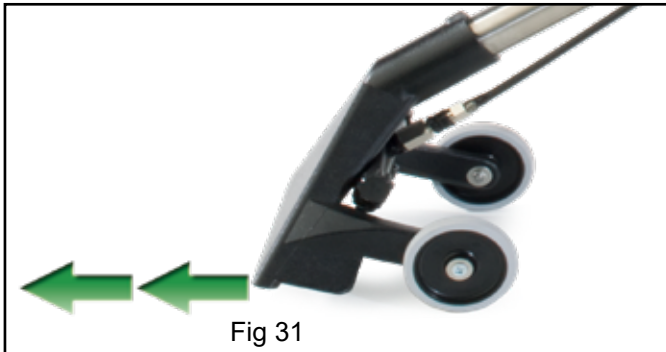

Fig 31

Lift the wand allowing the floor-tool blade to come in contact with the cleaning surface (Fig 32).

Operate the trigger (Fig 33), allowing the cleaning solution to penetrate the carpet and slowly draw the floor-tool rearward Vacuuming the cleaning solution up at the same time (Fig 35).

Work backwards towards the exit door. (fig 34)

For cleaning tips see page 2



Fig 32



Fig 33



Fig 34

Note.

Do not over wet remember 'What goes in, must come out again!.'



Fig 35

Using the hand tool



Fig 36

The NHL 15 comes with a quality upholstery tool

Fit the upholstery tool to the end of the hose.

Connect the solution tube (Fig 36)

Switch the machine on and operate the trigger to apply the cleaning solution (Fig 37).

The upholstery tool should only be used with the low pressure setting.



Fig 37

Cleaning the machine

Emptying the waste water



You can empty the waste water tank by using the dump hose attached to the rear of the machine (Fig 38).

The waste water tank can also be removed and carried using the handle to a suitable waste disposal area and emptied (Fig 39).

Follow the national guide lines when disposing of chemicals. (COSHH) see page 11



Removing the wands and floor-tool

Caution.

The solution tube will be under pressure, switch off the pump and operate the trigger to release the pressure in the system BEFORE removing the solution tube from the machine.



Unclip the solution tube from the machine see NOTE above.

Remove the wands, floor-tool (Fig 40) and hose assembly from the machine (Fig 41).



Cleaning the tanks, filters and hoses.



To keep your NUMATIC machine in pristine condition

Clean all filters and tanks regularly.

Remove the waste tank vacuum filter (Fig 42) and clean.





Fig 43

Located in the bottom of the NuChem / water tank is a barrel filter (Fig 43).

Clean if necessary.



Ensure the machine is cleaned and all hoses and tubes are flushed with cold clean water (fig 44).



Fig 44

After use, ensure the solution tube has been flushed with clean water for at least 60 seconds.

Blocked nozzles

If the spray nozzles are blocked, they have been designed to be easily cleaned. Undo the spray nozzle cap (Fig 45) remove (Fig 46) check the 'O' ring for damage replace if necessary (Fig 47) and clean the nozzles (Fig 48).



Fig 45



Fig 46



Fig 47



Fig 48

Note.

Inspect the O ring seal and replace if necessary (Fig 47).

Maintenance



Fig 49

Certain components are located in the bottom of the machine (Fig 49).

Vacuum filter housing. (A)

Mains 6.3 amp time lag fuse holder x 2. (B)

Plugged cable. (C)

Always ensure the machine has been unplugged from the electric supply BEFORE attempting any repairs.

Replacing the vacuum filter



Fig 50

To gain access to this filter remove the filter cover (Fig 50).

Periodically, clean or renew the filter using (207119) Vacuum filter

It is recommended you only use genuine NUMATIC parts.

Replacing the vacuum and pump fuses



Fig 51

Under the rectangular plate is 6.3 amp time lag fuse holder Remove the plate (Fig 51).

Fuse (B) (See fig 52) is the mains fuse x 2.

Replace using (220179) 6.3 amp time lag fuses (Fig 54).

It is recommended you only use genuine NUMATIC parts.



Fig 52



Fig 53

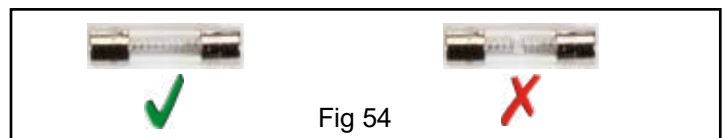

Fig 54

Changing the cable



Fig 55

Check the cable before use if the cable is found to be damaged or scuffed (fig 55) replace with a genuine Numatic part.

The Cable has been designed to be changed easily.

Unscrew the cable / fuse cover plate (fig 56)

Ensure you dispose of the cable in a proper manner.

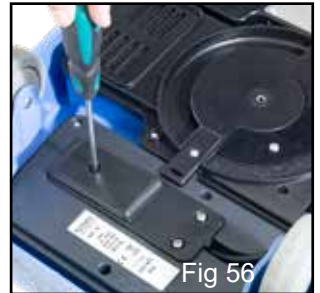

Fig 56



Fig 57

Lift the cable off the pins (fig 57) and remove from the plastic clips (fig 58).



Fig 58

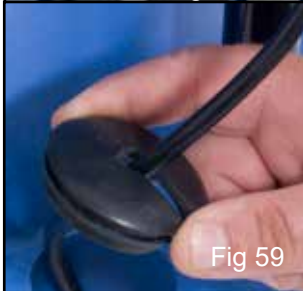

Fig 59

Remove the rubber grommet, free the cable from the machine (fig 59)

Unscrew the cable strain relief and replace the cable.

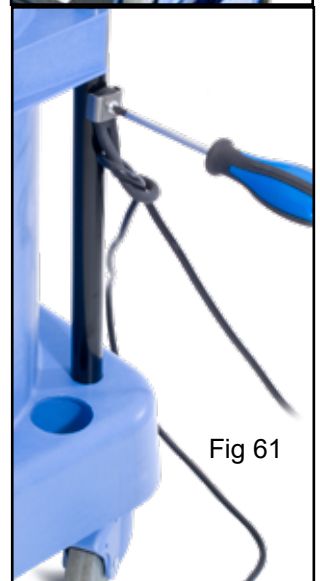

Fig 61



Fig 60

Fit the new cable to the strain relief (fig 60) and refit to the machine (fig 61).

Refit Grommet and clip cable in place to the bottom of the machine (fig 62).

Refit cover and secure with the 3 retaining screws (fig 63).



Fig 62





Fig 63

Trouble-Shooting

PROBLEM	CAUSE	SOLUTION
Machine will not operate	Missing or blown plug fuse. Mains power cable damaged.	Replace fuse. Replace damaged cable.
Vacuum will not operate	Vacuum not turned on. Vacuum fuse missing or blown.	Turn on vacuum. Replace missing or blown fuse.
Pump will not operate	Pump not turned on. Pump fuse missing or blown.	Turn on vacuum. Replace missing or blown fuse.
Poor water pick up	Waste tank full. Clogged / blocked vacuum hose. Blocked floor-tool. Waste tank not locked in place.	Empty waste tank. Remove and clean. Remove and clean. Lock in place (see page 12)
Little or no water flow.	Clean-water tank empty Clean-water tank filter blocked Nozzles blocked	Fill clean-water tank. Remove and clean. Remove and clean.

Recommended Spare Parts NHL 15

Part number	Description	Part number	Description
237193	Dome	607248	BS27 Kit
525010	Top bucket c/w dump hose	602399	4.0m Hose
525009	Drum c/w water fittings	602922	Wand (bend)
313100	Castor (x4 Pack)	602920	Wand (Straight)
207119	Vac filter	602937	Wand (Extension)
220179	6.3 amp time lag fuse	602200	Tri jet floor tool
208464	Filter cap	602300	Solution tube c/w trigger
236010	UK plugged cable (10m)	602225	Upholstery tool
236124	Euro plugged cable (10m)		
236018	Swiss plugged cable (10m)	607246	B26 Kit
236022	South African cable (10m)	602399	4.0m Hose
208425	Brass spray nozzle	602225	Upholstery tool
291023	'O' Ring		

	Failure to rectify the problem or in the event of a breakdown contact your Numatic dealer or the Numatic Technical Helpline +44 (0)1460 269268
	Wenn Sie das Problem nicht beheben können oder wenn es zu einer Störung kommt, wenden Sie sich an Ihren Numatic-Händler oder rufen Sie bei der Numatic Technical Helpline an unter 0049 (0)511 9842160.
	Si vous ne parvenez pas résoudre le problème ou en cas de panne, contactez votre revendeur Numatic ou le service d'assistance technique Numatic au +33164726161
	Neem contact op met uw Numatic-verdeler als u het probleem niet kunt verhelpen of de machine dienst weigert. U kunt ook de technische hulplijn van Numatic bellen op +31 172 467 999
	Failure to rectify the problem or in the event of a breakdown contact your Numatic dealer or the Numatic Technical Helpline 0861 686 284

Wiring Diagram

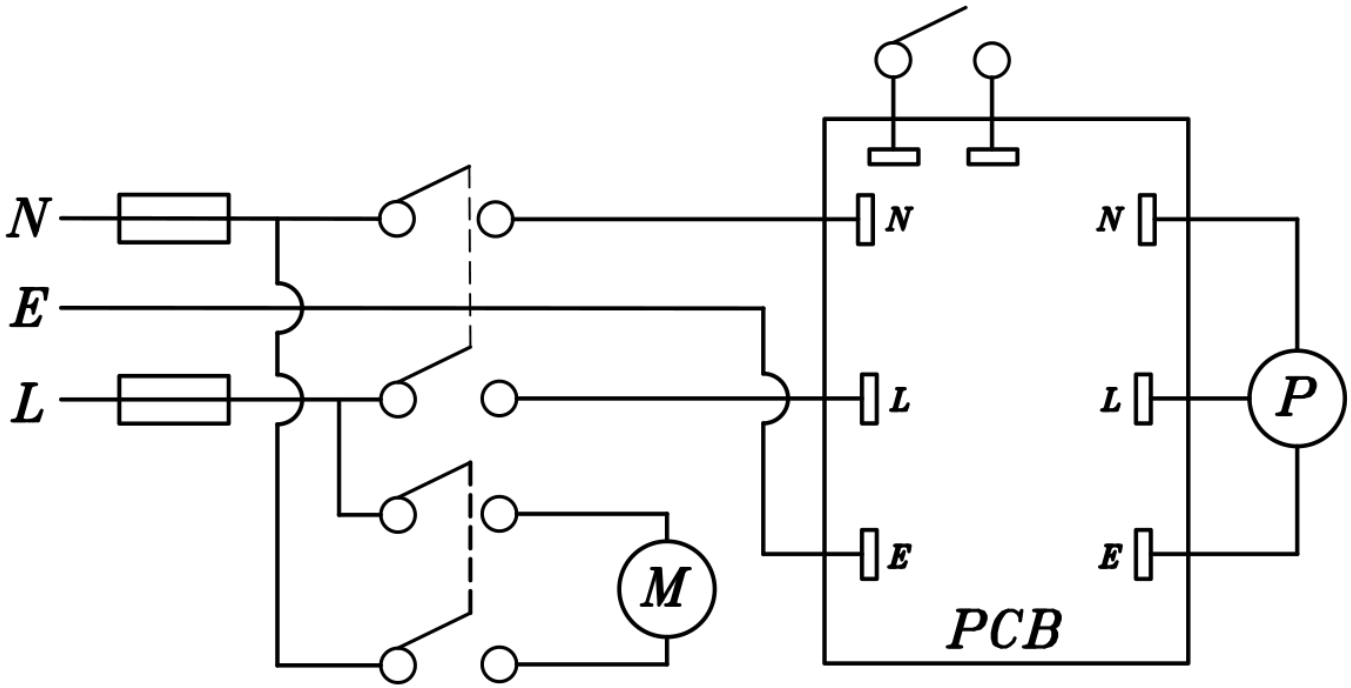

Notes

.....

.....

.....

.....

.....

.....

.....

.....

.....

.....

.....

.....

.....

.....

.....

.....

.....

Numatic International Warranty

Numatic International Limited warrant to the original purchaser that its products are free of defects in both material or workmanship for the period shown below:-

Homecare and Cleancare Vacuum cleaners.....	2 Years
Rotary Floor Machines.....	2 Years
Twintec Auto Scrubber Dryer.....	1 Year
Vario Ride-On Scrubber Dryer.....	1 Year / 1500 hours
Mopping, Compacts, Combi and Servocare Products.....	1 Year
Individual Accessories and Spare Parts.....	6 Months

Note: This warranty expressly excludes consumable parts such as carbon brushes, floor brushes, mops, batteries etc, that are considered replaceable from time to time during the normal working life of the machine.

Using non Numatic dustbags can be detrimental to both machine performance and life and may invalidate the Warranty.

- A. The warranty period commences from the date the goods are purchased.*
- B. All warranty claims must be processed through the Dealer from whom the equipment was purchased. The Dealer will co-operate with the purchaser throughout the warranty claims procedure and will arrange any necessary repairs using genuine Numatic parts.*
- C. If the original Dealer is no longer able to fulfil his obligations please contact Numatic International Limited with full details of the claim and proof of purchase so that this may be processed without delay.*
- D. Any warranty claim can only relate to the specific part that is proven to be at fault and for which a replacement will be supplied but cannot be extended to constitute a claim against the complete machine.*
- E. Numatic International will supply the Dealer with any warranty parts required, subject to the claim being validated, after return of the faulty items in accordance with Numatic International Limited's General Conditions of Sale.*
- F. Claims will not be accepted if they are the result of fair wear and tear, misuse or abuse of any kind.*
- G. No replacement will be given unless the appropriate evidence of the validity of the claim has been provided to the satisfaction of Numatic International Limited.*
- H. Numatic International Limited reserve the right to charge for any unnecessary work carried out as a result of an invalid claim.*
- I. No variation to this warranty may be made or implied by any member of Numatic International Limited or its Dealers unless such variation is in writing and authorised by the Company*



Numatic International Limited. Chard, Somerset, TA20 2GB

Telephone: 01460 68600 Fax: 01460 68458

© Numatic International Limited



Numatic International Limited.
Chard, Somerset TA20 2GB ENGLAND
Tel: 01460 68600 www.numatic.co.uk



Numatic International GmbH. Fränkische Straße 15–19
D-30455 Hannover, DEUTSCHLAND
Tel: 05 11 98 42 16 0 www.numatic.de



Numatic International SAS. EAE La Tuilerie – 13 / 17 rue du Valengelier
77500 CHELLES, FRANCE
Tel: 01 64 72 61 61 www.numatic.fr



BeNeLux Distribution, Numatic International BV
Postbus 101, 2400 AC Alphen aan den Rijn, NEDERLAND
Tel: 0172 467 999 www.numatic.nl



Numatic International (Pty.) Ltd.
16th & Pharmaceutical Roads, Midrand, Gauteng,
SOUTH AFRICA 1685
Tel: 0861 686 284 www.numatic.co.za



Numatic International Schweiz AG.
Sihlbruggstrasse 3A, 6340 Baar. SCHWEIZ
Tel: 0041 (0) 41 76 80 76 - 0 www.numatic.ch



Numatic International ULDA. Rua da Boa Viagem, 177
4470.210 Maia. PORTUGAL
Tel: +351 220 047 700 www.numatic.pt



Numatic International SLU. C/ La Forja, 41, 08840 Viladecans
(Barcelona), Spain
Tel: +34 93 647 22 22 www.numatic.es

Specification subject to change without prior notice
www.numatic.co.uk © Numatic International Limited