

Owner Instructions
Bedienerhandbuch
Mode d'emploi
Bedieningshandleiding voor de gebruiker

NR 1500 / NRL 1500 NRS 450 NRT 1530 NRU
1500



Original Instructions
Warning! Read instructions before using the machine.
Warnhinweis
Lesen Sie vor Gebrauch der Maschine das Handbuch.
Attention
Lisez la notice avant d'utiliser la machine.
Waarschuwing
Lees deze instructies voor u de machine gebruikt



www.numatic.com

1

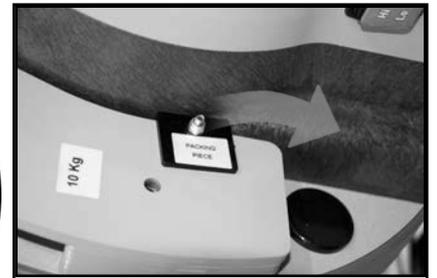

NR 40 / 50Kg
NRT 40 / 50 Kg

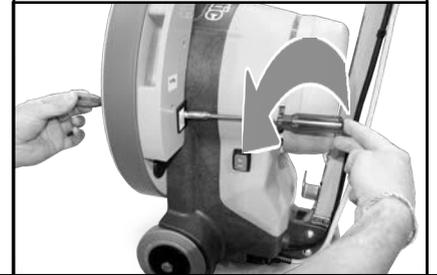

2B



3A



3B

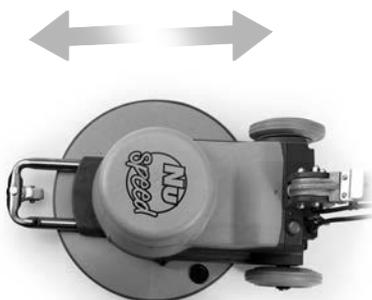

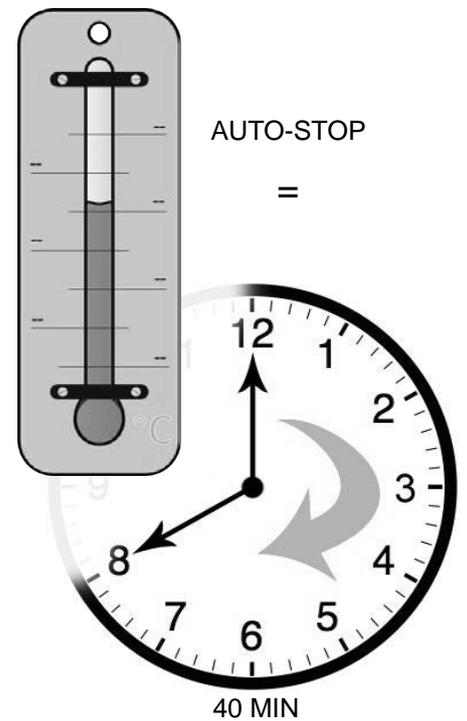
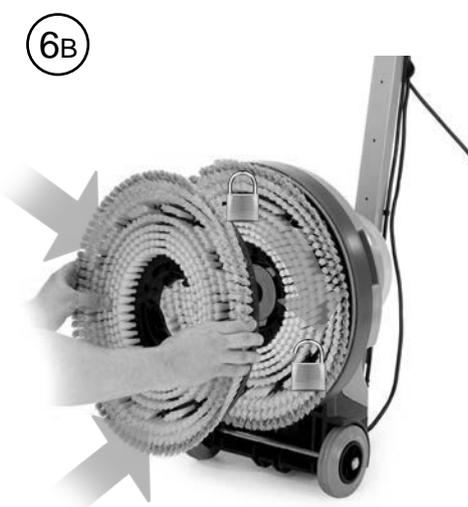
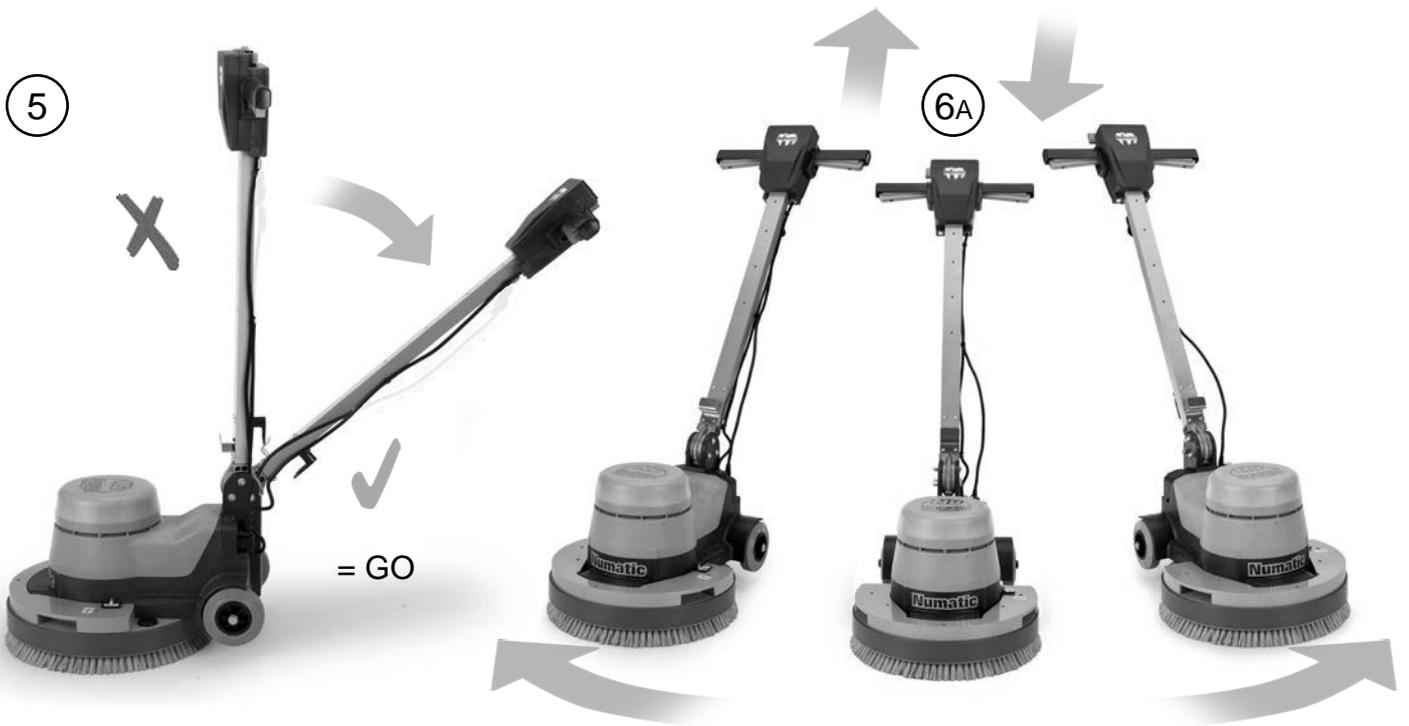
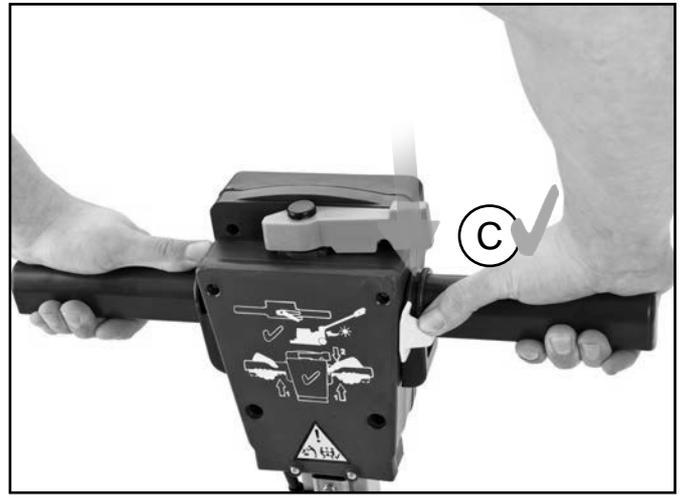
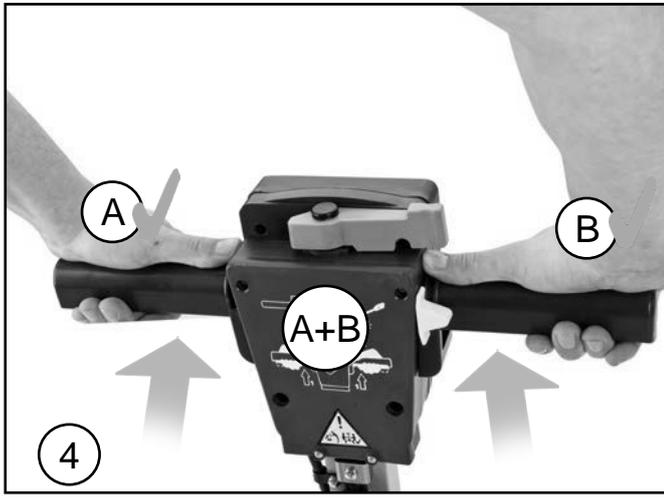

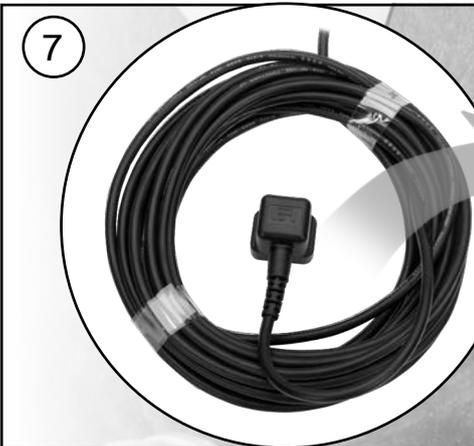
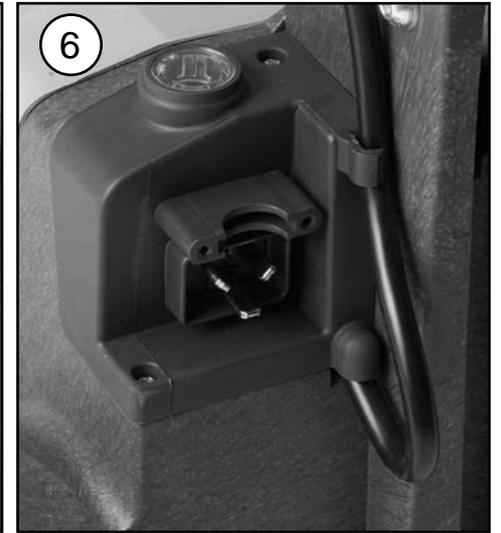
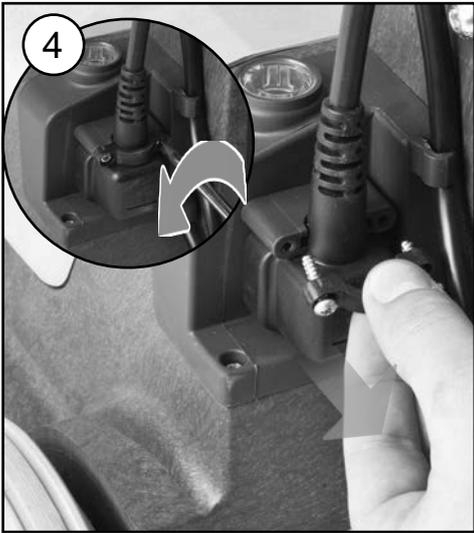
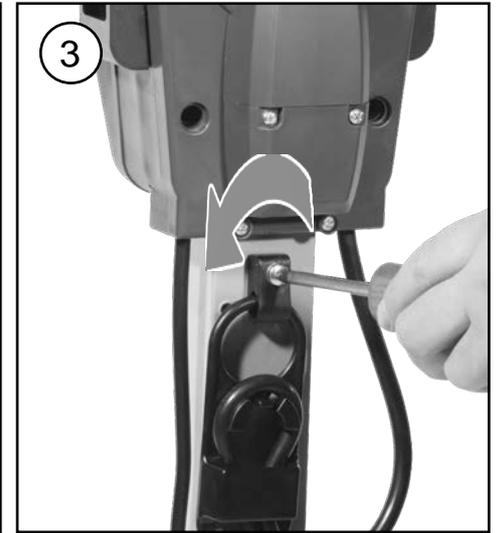
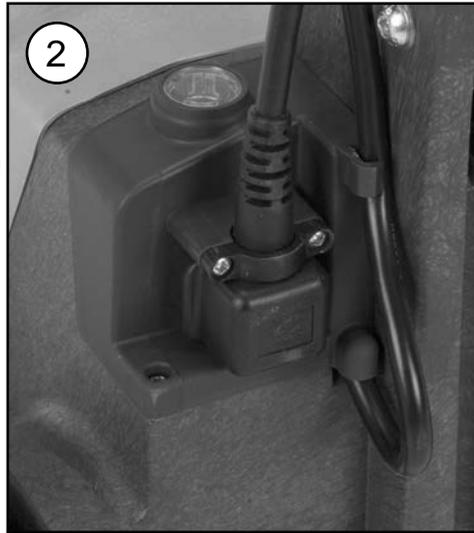
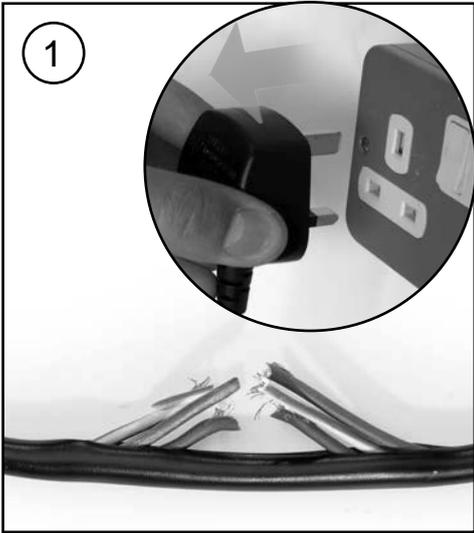

WHEN ATTACHED TO THE DEVICE, PLEASE REFER TO THE INSTRUCTIONS FOR USE.

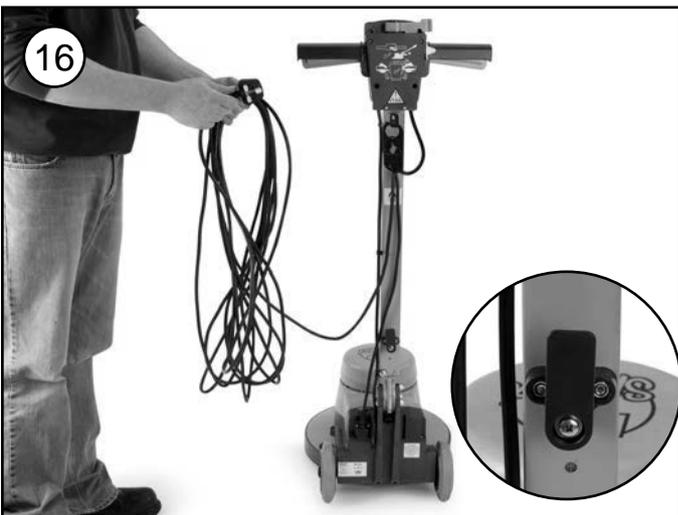
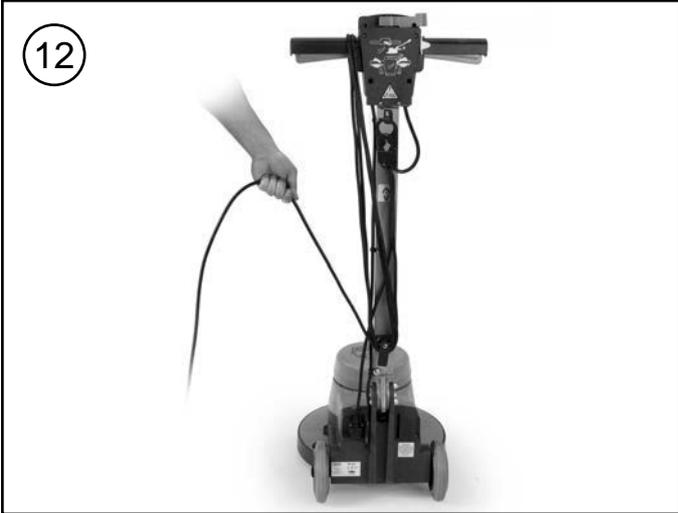



Rating Label

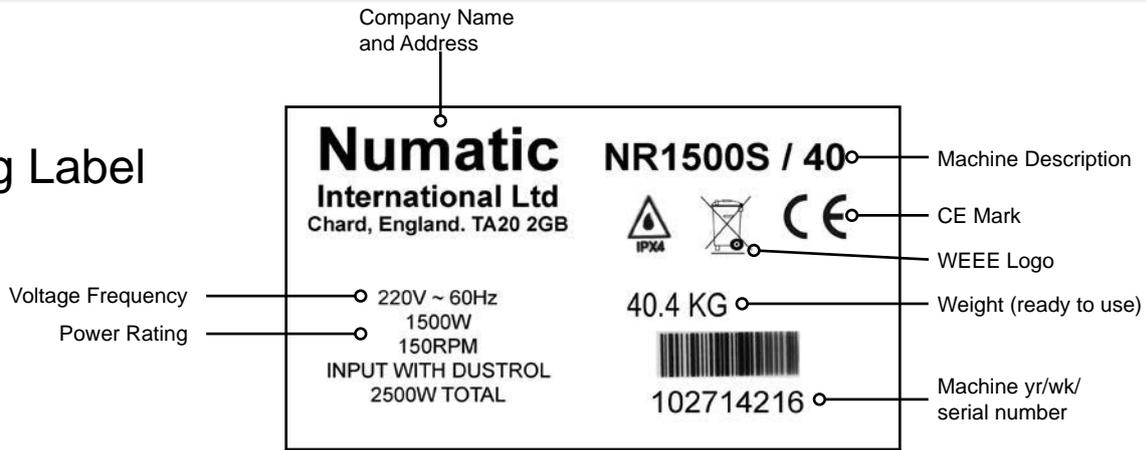

Safety Critical Components

Mains Lead

HO5VV-F x 15M x 3 x 1.5mm²

Floor Machine, accessories and packaging should be sorted for environmental-friendly recycling

Only for EU countries:

Do not dispose of Floor Machine into household waste!
According to the European Directive 2002/96/EC on Waste Electrical and Electronic Equipment and its incorporation into national law. Floor Machine that are no longer suitable for use must be separately collected and sent for recovery in an environmentally - friendly manner.

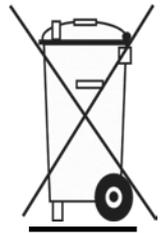

PPE
(personal protective equipment)
that may be required for certain operations.



Safety Footwear



Hat Protection



Ear Protection



Safety Gloves



Dust / Allergens Protection



Eye Protection



Protective Clothing



Caution Floorsign

NOTE:

A risk assessment should be conducted to decide what PPE should be worn.



ORIGINAL INSTRUCTIONS READ MANUAL BEFORE USE

CAUTION:

Read the instruction manual before using the appliance

NOTE:

This Product meets the requirements of BS EN 60335 - 2-67

This Machine is also suitable for commercial use, for example in hotels, schools, hospitals, factories, shops and offices for other the normal housekeeping purposes.

Care should be taken in the choice of chemicals, detergents and other liquids. Consult your supplier.

Do's and Don'ts:

- DO Ensure only competent persons unpack/ assemble the machine.
 - DO Keep your machine clean.
 - DO Keep your brushes in good condition.
 - DO Replace any worn or damaged parts immediately.
 - DO Daily examine the mains lead for damage, such as cracking or aging. If damage is found, replace the lead before further use.
 - DO Only replace the mains lead with the correct Numatic approved replacement part.
 - DO Ensure that the work area is clear of obstructions and/ or people.
 - DO Ensure that the working area is well illuminated.
 - DO Pre - sweep the area to be cleaned.
 - DO Remove packing piece NR, NRT 40 / 50 Kg machines.
-
- DON'T Use steam cleaners or pressure washers to clean the machine or use in the rain.
 - DON'T Attempt machine maintenance or cleaning unless the power plug has been removed from the supply outlet.
 - DON'T Allow any inexperienced repairs. Contact your nearest service centre.
 - DON'T Strain the mains lead or try to unplug by pulling on the mains lead.
 - DON'T Leave the brush deck in the lowered position when not in use.
 - DON'T Expect the machine to provide trouble free, reliable operation unless maintained correctly.
 - DON'T Run the machine over any power cables during operation.
 - DON'T Leave your machine standing on brush, pads or drive boards, when not in use.

WARNING:

Operators shall be adequately instructed on the use of this machine.

This machine shall be disconnected from its power source (Remove plug from socket outlet.) During cleaning or maintenance or in the event of an accident and when replacing parts or converting the machine to another function. This machine is not suitable for picking up hazardous dust.

Do not allow supply cord to come into contact with the rotating brushes or pads

As with all electrical equipment care and attention must be exercised at all times during its use, in addition to ensuring that routine and preventive maintenance is carried out

Periodically in order to ensure its safe operation. Failure to carry out maintenance as necessary, including the replacement of parts to the correct standard could render the equipment unsafe and the manufacturer can accept no responsibility or liability in this respect.

When ordering spare parts always quote the model number / serial number specified on the rating plate.

This machine is for indoor use only.

The machine is not to be used or stored outdoors or in wet conditions.

Don't allow the machine to be used by inexperienced or unauthorised operators or without appropriate training.

Only use brushes provided with the appliance or those specified in the instruction manual.

The use of other brushes may impair safety.

A full range of brushes and accessories are available for this product.

Only use brushes or pads which are suitable for the correct operation of the machine for the specific task being performed.

It is essential that this equipment is correct assembled and operated in accordance with current safety regulations. When using the equipment always ensure that all necessary precautions are taken to guarantee the safety of the operator and any other persons who may be affected.

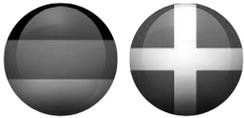

Produktplakette

Name und Anschrift des Unternehmens

Numatic
International Ltd
 Chard, England. TA20 2GB

220V ~ 60Hz
 1500W
 150RPM
 INPUT WITH DUSTROL
 2500W TOTAL

NR1500S / 40

IPX4

40.4 KG

CE

WEEE Logo

(Nutz-) Gewicht

Gerät Jahr/Woche
 Seriennummer

102714216

Spannung / Frequenz

Nennleistung

Bezeichnung der Maschine

CE-Kennzeichnung

WEEE Logo

(Nutz-) Gewicht

Gerät Jahr/Woche
 Seriennummer

Sicherheitsrelevante Bestandteile

Stromversorgung

HO5VV-F x 15M x 3 x 1.5mm²

WEEE-Richtlinie

Einscheibenmaschine, Zubehör und Verpackung müssen getrennt entsorgt werden, um ein umweltfreundliches Recycling zu ermöglichen.

Für EU-Länder gilt:

Entsorgen Sie Einscheibenmaschine nicht im Hausmüll!

- gemäß EU-Richtlinie 2002/96/EC über die Entsorgung von Elektro- und Elektronikgeräten sowie deren Umsetzung in nationales Recht.

Einscheibenmaschine, die nicht mehr verwendet werden können, sind getrennt zu sammeln und zur umweltfreundlichen Entsorgung abzugeben.

In Deutschland sind das i.d.R. Sammelstellen beim örtlichen Entsorger.



PSA

(PERSÖNLICHE SCHUTZAUSRÜSTUNG)

KANN FÜR BESTIMMTE ARBEITEN MIT DEM GERÄT ERFORDERLICH SEIN.



Sicherheitsschuhe



Kopfschutz



Ohrschutz



Sicherheitshandschuhe



Staub-/Allergieschutz



Augenschutz



Schutzkleidung



Hinweisschild „Achtung Rutschgefahr“

Hinweis:

Zur Entscheidung, welche PSA zu tragen ist, sollte eine Risikoabschätzung vor Ort vorgenommen werden.

(Änderungen vorbehalten)

Informationen für Einscheibenmaschine

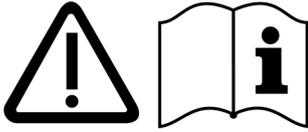

ORIGINALANLEITUNG VOR GEBRAUCH AUFMERKSAM UND VOLLSTÄNDIG LESEN

VORSICHT:

Lesen Sie das Handbuch gründlich durch, bevor Sie das Gerät einsetzen.

ANMERKUNG:

Dieses Produkt erfüllt die Anforderungen gemäß BS EN 60335 - 2-67

Dieses Gerät ist zusätzlich zu seiner Verwendbarkeit in privaten Haushalten auch für den gewerblichen Einsatz geeignet, beispielsweise in Hotels, Schulen, Krankenhäusern, Fabriken, Läden und Büros.

Alle Chemikalien, Waschmittel und andere Flüssigkeiten sind mit Sorgfalt auszuwählen. Wenden Sie sich dazu an Ihren Anbieter.

Worauf zu achten ist:

- Stellen Sie sicher, dass nur entsprechend befähigte Personen das Gerät auspacken/zusammenbauen.
- Halten Sie das Gerät sauber.
- Halten Sie die Bürsten in einem guten Zustand.
- Ersetzen Sie abgenutzte oder beschädigte Teile unverzüglich.
- Überprüfen Sie das Netzkabel täglich auf Beschädigungen, wie z. B. Risse oder Alterungserscheinungen. Wenn Sie feststellen, dass das Kabel beschädigt ist, ersetzen Sie es, bevor Sie weiterarbeiten.
- Ersetzen Sie das Netzkabel nur durch das korrekte, von Numatic genehmigte Ersatzteil.
- Stellen Sie sicher, dass sich keine Hindernisse oder Personen im Arbeitsbereich befinden.
- Achten Sie darauf, dass der Arbeitsbereich gut beleuchtet ist.
- Wischen Sie den zu reinigenden Bereich vor.
- Entfernen Sie die Transportsicherung an den NR, NRT 40, 50 kg Maschinen.

- Verwenden Sie KEINE Dampf- oder Druckreiniger zum Reinigen des Geräts, und verwenden Sie das Gerät NICHT im Regen.
- Führen Sie KEINE Wartungs- oder Reinigungsarbeiten am Gerät durch, wenn der Netzstecker noch in der Steckdose steckt.
- Lassen Sie Reparaturarbeiten NICHT von unerfahrenen Personen durchführen. Wenden Sie sich an das nächstgelegene Service-Center.
- Belasten Sie NICHT das Netzkabel, und versuchen Sie NICHT, den Netzstecker am Netzkabel herauszuziehen.
- Lassen Sie das Bürstendeck NICHT in der abgesenkten Position, wenn es nicht gebraucht wird.
- Gehen Sie davon aus, dass das Gerät NUR dann störungsfrei und zuverlässig betrieben werden kann, wenn es ordentlich gewartet wird.
- Fahren Sie mit dem Gerät im Einsatz NICHT über Strom führende Kabel.
- Die Maschine nach Gebrauch nicht auf der Bürste oder dem Pad/Treibteller abstellen.

WARNUNG:

Benutzer müssen ausführlich in den Gebrauch dieses Geräts eingewiesen werden.

Dieses Gerät muss von seiner Stromversorgung getrennt werden (der Netzstecker muss gezogen werden), während das Gerät gereinigt oder gewartet wird, wenn es zu einem Unfall gekommen ist, wenn Teile am Gerät ausgetauscht werden oder wenn das Gerät in einen anderen Verwendungsmodus umgeschaltet wird.

Dieses Gerät ist nicht für die Aufnahme von gefährlichem Staub geeignet.

Rotierende Bürsten oder Pads dürfen nicht mit elektrischen Leitungen in Berührung kommen.

Wie bei allen elektrischen Geräten ist während der Benutzung jederzeit Vorsicht und Aufmerksamkeit geboten. Darüber hinaus muss zur Gewährleistung eines sicheren Betriebs in regelmäßigen Abständen eine laufende und vorbeugende Wartung durchgeführt werden. Wenn Sie die Wartung nicht im nötigen Umfang durchführen, darin eingeschlossen das Verwenden von korrekten Ersatzteilen, kann die Sicherheit des Geräts beeinträchtigt werden, und der Hersteller kann weder die Verantwortung noch eine Haftung in dieser Hinsicht übernehmen.

Nennen Sie bei der Bestellung von Ersatzteilen immer die Modell- oder Seriennummer, die auf dem Leistungsschild angegeben ist.

Dieses Gerät ist nur für den Einsatz im Innenbereich ausgelegt.

Das Gerät darf in Außenbereichen oder unter feuchten Bedingungen weder eingesetzt noch abgestellt werden.

Das Gerät darf nicht von unerfahrenen, nicht berechtigten bzw. nicht entsprechend geschulten Personen bedient werden.

Verwenden Sie nur die Bürsten, die zusammen mit dem Gerät geliefert wurden bzw. die im Handbuch angegeben sind.

Durch die Verwendung anderer Bürsten kann die Sicherheit beeinträchtigt werden.

Für dieses Produkt ist ein umfassender Satz an Bürsten und weiteren Zubehörteilen erhältlich.

Verwenden Sie nur Bürsten oder Pads, die für den korrekten Betrieb des Geräts bei der speziellen durchzuführenden Aufgabe geeignet sind.

Es ist entscheidend, dass dieses Gerät richtig zusammgebaut und entsprechend den aktuell geltenden Sicherheitsvorschriften bedient wird. Stellen Sie bei Verwendung des Geräts stets sicher, dass alle notwendigen Sicherheitsvorkehrungen umgesetzt wurden, um die Sicherheit des Bedieners sowie anderer, möglicherweise betroffener Personen zu gewährleisten.

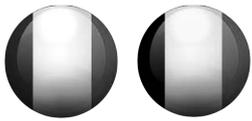

Plaque signalétique

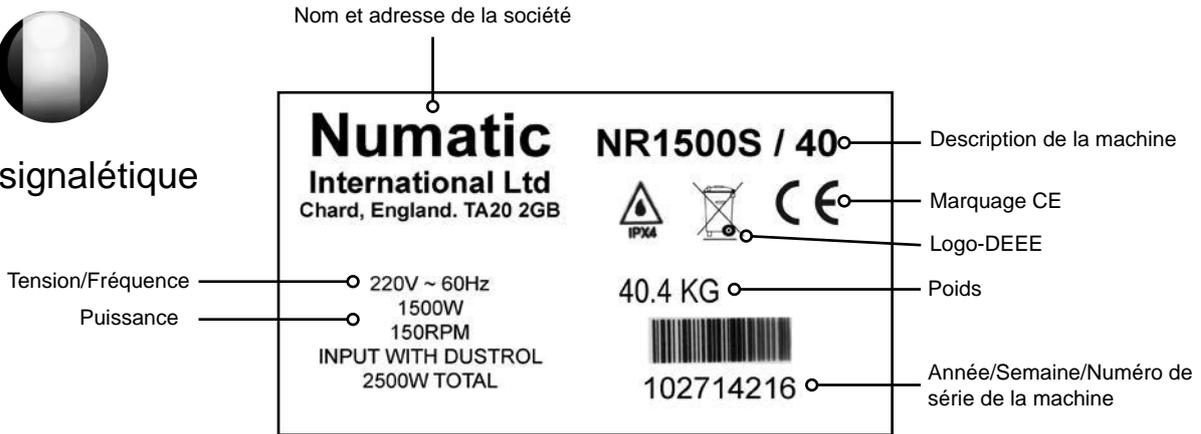

Composants critiques pour la sécurité

Câble d'alimentation

HO5VV-F x 15M x 3 x 1.5mm²

Législation WEEE (DEEE)

Monobrosse, ses accessoires et son emballage doivent être triés pour un recyclage écologique.

Pays de l'UE uniquement :

Ne jetez pas Monobrosse avec les ordures ménagères.

Selon la directive européenne 2002/96/CE relative aux déchets d'équipements électriques et électroniques (DEEE) et à sa transposition au droit national,

Monobrosse qui ne sont plus utilisables doivent faire l'objet d'une collecte sélective et être traités d'une manière respectueuse de l'environnement.

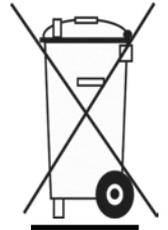

EPI

(Equipement de protection individuelle)

Il peut être nécessaire pour certaines opérations.



Chaussures de sécurité



Casque de protection



Protections sonores



Gants de sécurité



Protection contre la poussière/les allergènes



Protection des yeux



Vêtements de protection



Panneau de signalisation au sol

Note :

Une évaluation des risques devra être menée pour définir les obligations d'utilisation des EPI.

(sujet à modification sans préavis)

Informations concernant Monobrosse



Veillez lire le manuel d'instruction avant d'utiliser l'appareil.
Les utilisateurs doivent être correctement formés à l'utilisation de ces appareils.

MISE EN GARDE :

Lisez le mode d'emploi avant d'utiliser l'appareil.

REMARQUE :

Ce produit est conforme aux exigences de la norme BS EN 60335 - 2-67

Cette machine est également adaptée à un usage commercial, par exemple pour les hôtels, les écoles, les hôpitaux, les usines, les magasins et les bureaux à des fins autres que les besoins ménagers normaux.

Un soin particulier doit être pris dans le choix des produits chimiques, détergents et autres liquides. Consultez votre fournisseur.

Choses à faire et à ne pas faire :

Veillez à ce que seules des personnes compétentes déballent/assemblent la machine.

Maintenez votre machine propre.

Maintenez vos brosses en bon état.

Remplacez immédiatement toute pièce usée ou endommagée.

Examinez régulièrement le câble d'alimentation pour voir s'il comporte des traces d'endommagement telles que des fissures ou un vieillissement. S'il est endommagé, remplacez-le avant toute nouvelle utilisation.

Remplacez le câble d'alimentation uniquement avec la pièce de rechange correcte approuvée par Numatic.

Assurez-vous que la zone de travail n'est pas encombrée et que personne ne passe par là.

Assurez-vous que la zone de travail est bien éclairée.

Balayez au préalable la zone à nettoyer.

Retirer morceau d'emballage NR, NRT 40 / 50 Kg machines.

N'utilisez pas de nettoyeurs à vapeur ou de nettoyeurs haute pression pour nettoyer la machine et évitez toute utilisation sous la pluie.

Ne procédez pas à l'entretien ou au nettoyage de la machine tant que celle-ci est branchée dans la prise de courant.

Ne laissez pas des personnes inexpérimentées effectuer des réparations. Contactez votre centre de service le plus proche.

N'exercez pas de traction excessive sur le câble, et ne débranchez jamais le câble en tirant dessus.

Ne laissez pas le plateau de brosses dans la position abaissée lorsqu'il n'est pas utilisé.

Ne négligez pas l'entretien de la machine si vous souhaitez qu'elle fonctionne de manière fiable et sans problème.

Ne roulez pas avec la machine sur des câbles électriques pendant l'utilisation.

Ne jamais entreposer ou laisser la machine à l'arrêt sur la brosse ou le plateau.

ATTENTION :

Les opérateurs doivent recevoir des instructions appropriées sur l'utilisation de ces machines.

Cette machine doit être débranchée de sa source d'alimentation (retirez la fiche secteur de la prise de courant) pendant le nettoyage ou l'entretien, ou en cas d'accident, ou pendant le remplacement de pièces ou la conversion de la machine pour changer de fonction.

Cette machine n'est pas conçue pour le ramassage de poussières dangereuses.

Ne laissez pas de fil électrique entrer en contact avec les brosses ou disques

Comme pour tout équipement électrique, il convient d'être prudent et vigilant à tout instant lorsqu'on l'utilise, en plus de s'assurer que son entretien courant et préventif est bien effectué régulièrement pour qu'il reste en bon état de fonctionnement. Si l'entretien nécessaire n'est pas effectué et si l'on ne remplace pas les pièces à changer par des pièces à la bonne norme, l'équipement pourrait devenir dangereux et le fabricant ne pourra accepter aucune responsabilité à cet égard.

Lorsque vous commandez des pièces de rechange, indiquez toujours le numéro du modèle / numéro de série indiqué sur la plaque signalétique.

Cette machine est réservée à un usage intérieur.

La machine ne doit pas être utilisée ni rangée à l'extérieur ou dans un environnement humide.

Ne laissez pas des opérateurs inexpérimentés, non autorisés ou sans formation appropriée utiliser la machine.

Utilisez uniquement les brosses fournies avec l'appareil ou celles qui sont spécifiées dans le mode d'emploi.

L'utilisation d'autres brosses peut nuire à la sécurité.

Une gamme complète de brosses et d'accessoires est disponible pour ce produit.

N'utilisez que des brosses ou des disques qui sont appropriés pour le fonctionnement correct de la machine pour la tâche spécifique effectuée.

Il est essentiel que cet équipement soit correctement monté et utilisé conformément aux normes de sécurité actuelles. Lors de l'utilisation de l'équipement, veillez toujours à ce que toutes les précautions nécessaires soient prises pour garantir la sécurité de l'opérateur et de toute autre personne qui pourrait être concernée.



Type Plaatje

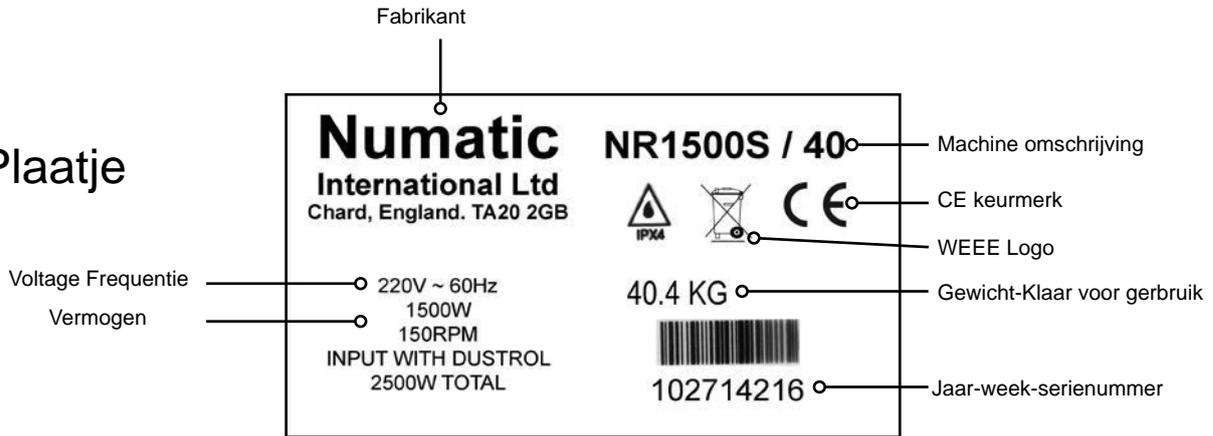

Veiligheidsgevoelige componenten

Aansluitsnoer

HO5VV-F x 15M x 3 x 1.5mm²

Eenschijf Machine, accessoires en verpakking dienen gesorterd te worden teneinde alle onderdelen milieuvriendelijk te weggooien

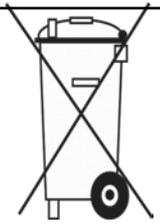

Geldt alleen voor EU landen

U mag Eenschijf Machine, volgens de Europese Richtlijn 2002/96/EN met betrekking tot het weggooien van elektronische apparatuur en zoals opgenomen in de Nederlandse wetgeving, niet met het huishoudelijk afval weggooien.

Eenschijf Machine die niet langer geschikt zijn voor gebruik moeten apart worden ingeleverd, zodat ze op een milieuvriendelijke manier kunnen worden verwerkt.

PERSOONLIJKE BESCHERMING

die vereist kan zijn bij het uitvoeren van bepaalde werkzaamheden



Veiligheidsschoeisel



Veiligheidshelm



Gehoorsbescherming



Veiligheidshandschoenen



Adembescherming



Oogbescherming



Beschermende kleding



Waarschuwbord

LET OP:

Een risico-inventarisatie dient te worden uitgevoerd teneinde te bepalen welke bescherming moet worden gebruikt.



Originele gebruiksaanwijzing Lezen voor gebruik

OPGELET:

Lees de gebruikershandleiding alvorens deze machine in gebruik te nemen

OPMERKING:

Dit product voldoet aan de norm BS EN 60335 - 2-67

Deze machine is tevens geschikt voor zwaar gebruik, d.w.z. zwaarder dan huishoudelijk gebruik, zoals bijvoorbeeld in hotels, scholen, ziekenhuizen, fabrieken, winkels en kantoren.

Let erop dat u steeds geschikte chemische producten, schoonmaakmiddelen en andere vloeistoffen gebruikt. Raadpleeg hiervoor uw leverancier.

Wat WEL en wat NIET te doen:

WEL - zorg ervoor dat de machine alleen door ervaren personen worden uitgepakt/gemonteerd.

WEL - houd de machine schoon.

WEL - houd de borstels in goede staat.

WEL - vervang versleten of beschadigde onderdelen meteen.

WEL – controleer de stroomkabel regelmatig op beschadigingen, zoals scheurtjes of slijtage. Vervang het snoer wanneer het is beschadigd, voordat u de machine opnieuw gaat gebruiken.

WEL - Vervang de stroomkabel uitsluitend door het betreffende en door Numatic goedgekeurde vervangende onderdeel.

WEL - zorg ervoor dat er zich geen obstakels en/of mensen in de werkzone bevinden.

WEL - zorg ervoor dat de werkzone goed verlicht is.

WEL - veeg de zone die u gaat schoonmaken vooraf schoon.

WEL - Verwijder het verpakkingsmateriaal stuk NR, NRT 40 / 50 Kg machines

NIET - gebruik geen stoomreiniger of hogedrukspuit om de machine schoon te maken en gebruik de machine nooit in de regen.

NIET – onderhoud of reinig de machine niet terwijl de stekker in het stopcontact steekt.

NIET - laat nooit reparaties door onbevoegden uitvoeren. Neem daarvoor steeds contact op met het dichtstbijzijnde servicecentrum.

NIET – zorg ervoor dat de kabel nooit strak wordt gespannen en haal de kabel nooit uit het stopcontact door eraan te trekken.

NIET - laat de borstelplaat niet omlaag staan wanneer deze niet in gebruik is.

NIET - verwacht niet dat de machine probleemloos zal werken wanneer deze niet correct wordt onderhouden.

NIET – rijd tijdens bedrijf niet met de machine over de stroomkabel.

De machine niet op de borstel, pad of aandrijfschijf laten rusten indien niet in gebruik.

WAARSCHUWING:

Gebruikers dienen goed geïnstrueerd te zijn voordat ze dit soort apparaat bedienen.

Deze machine dient van de stroombron te worden losgekoppeld (haal de stekker uit het stopcontact). Tijdens reiniging, onderhoud of reparatie van de machine, vervangen van onderdelen of het overschakelen naar een andere functie, dient de stroombron uitgeschakeld te zijn.

Deze machine mag niet worden gebruikt voor het opvegen van gevaarlijk stof.

Zorg ervoor dat het snoer niet in contact kan komen met draaiende borstels of pads

Zoals voor alle elektrische apparatuur dient tijdens gebruik steeds de nodige zorgvuldigheid in acht te worden genomen en moet regelmatig periodiek en preventief onderhoud worden uitgevoerd om de veiligheid van de machine te kunnen garanderen. Het niet uitvoeren van het nodige onderhoud of het vervangen van onderdelen door inferieure onderdelen, kan de veiligheid in gevaar brengen. De fabrikant kan hiervoor in geen geval aansprakelijk worden gesteld.

Vermeld bij het bestellen van reserveonderdelen steeds het op het kenplaatje vermelde modelnummer/serienummer.

Deze machine is uitsluitend voor gebruik binnen bestemd.

De machine mag niet buiten of in vochtige omgevingen worden gebruikt of opgeborgen.

De machine mag niet worden gebruikt door onervaren of onbevoegde bedieners die niet de nodige opleiding hebben gekregen.

Gebruik enkel borstels die bij de machine worden geleverd of borstels die uitdrukkelijk in de gebruikershandleiding staan vermeld.

Het gebruik van andere borstels kan de veiligheid in gevaar brengen.

Er is voor deze machine een volledig gamma borstels en accessoires verkrijgbaar.

Gebruik enkel borstels of pads die een goede werking van de machine en een correcte uitvoering van de betreffende taak garanderen. Het is van het grootste belang dat deze machine correct wordt gemonteerd en bediend conform de geldende veiligheidsvoorschriften. Let er bij het gebruiken van deze machine steeds op dat alle nodige voorzorgsmaatregelen worden genomen om de veiligheid van de bediener en mogelijke omstaanders te garanderen.

Declaration of Conformity

CE 16
EU DECLARATION OF CONFORMITY
We hereby declare under our sole responsibility that the following equipment fulfills all the relevant provisions of the following EU Directives:
Machinery Directive 2006/42/EC
EMC Directive 2014/30/UE
RoHS Directive 2011/65/UE
Machine Description: Floor Machine series
Type: NPR, NR, NRL, NRT, NRS, NRU
Manufactured by: Numatic International Limited
Relevant standards upon which conformity is declared include:
IEC 60335-1 2001 + A1 2004 + A2 2006 + National Deviations
IEC 60335-2:67 2002 + A1 2004
EN 55014-1:2006
EN55014-2:1997+A1
EN61000-3-2:2006
EN61000-3-3:1995+A1+A2
BS EN 50366:2003
A technical construction file for this equipment is retained at the manufacturer's address under the authorisation of the following signatory:
Name: Ailyn Boyes **Position:** Technical Manager
Signed:  Date: 20/04/2016
 Numatic International Limited, Chard, Somerset, TA20 2GB www.numatic.co.uk **GB**

CE 16
EU Konformitätserklärung
Wir erklären in alleiniger Verantwortung, dass die folgenden Geräte alle einschlägigen Bestimmungen der folgenden EU-Richtlinien erfüllen:
Maschinenrichtlinie 2006/42/EC
EMC Richtlinie 2014/30/UE
RoHS Richtlinie 2011/65/UE
Maschinenbezeichnung: Einschleibemaschine
Type: NPR, NR, NRL, NRT, NRS, NRU series
Hersteller: Numatic International Limited
Relevante Normen auf die Konformität erklärt wird beinhalten:
IEC 60335-1 2001 + A1 2004 + A2 2006 + Nationale Abweichungen
IEC 60335-2:67 2002 + A1 2004
EN 55014-1:2006
EN55014-2:1997+A1
EN61000-3-2:2006
EN61000-3-3:1995+A1+A2
BS EN 50366:2003
Eine technische Dokumentation für diese Geräte wird an der Adresse des Herstellers unter der Verantwortung des Unterzeichners aufbewahrt:
Name: Ailyn Boyes **Stellung:** Technischer Leiter
Unterschrift:  Datum: 20/04/2016
 Numatic International Limited, Chard, Somerset, TA20 2GB www.numatic.co.uk **DE**

CE 16
DECLARATION DE CONFORMITE EUROPEENNE
Nous soussignés déclarons sous notre seule et unique responsabilité que les équipements suivants remplissent toutes les dispositions concernant les directives européennes suivantes:
Machinery Directive 2006/42/EC
EMC Directive 2014/30/UE
RoHS Directive 2011/65/UE
Description Machine: Monobrosses
Type: NPR, NR, NRL, NRT, NRS, NRU
Fabriqué par: Numatic International Limited
La présente conformité inclut les normes d'applications suivantes:
IEC 60335-1 2001 + A1 2004 + A2 2006 + Dérégations Nationales
IEC 60335-2:67 2002 + A1 2004
EN 55014-1:2006
EN55014-2:1997+A1
EN61000-3-2:2006
EN61000-3-3:1995+A1+A2
BS EN 50366:2003
Un dossier technique concernant la fabrication de cet équipement est conservé au siège social du fabricant sous l'autorisation du signataire suivant:
Nom: Ailyn Boyes **Position:** Responsable Technique
Signé par:  Date: 20/04/2016
 Numatic International Limited, Chard, Somerset, TA20 2GB www.numatic.co.uk **FR**

CE 16
EU CONFORMITEITSVERKLARING
Wij verklaren hierbij dat de volgende producten zijn ontwikkeld en geproduceerd in overeenstemming met de volgende normen en voorschriften:
Machine richtlijn 2006/42/EC
EMC Richtlijn 2014/30/UE
RoHS Richtlijn 2011/65/UE
Omschrijving machine: Enschildsmachines
Model: NPR, NR, NRL, NRT, NRS, NRU series
Gefabriceerd door: Numatic International Limited
Relevante normen waarop de conformiteit is verklaard, zijn inclusief:
IEC 60335-1 2001 + A1 2004 + A2 2006 + Nationale afwijkinge
IEC 60335-2:67 2002 + A1 2004
EN 55014-1:2006
EN55014-2:1997+A1
EN61000-3-2:2006
EN61000-3-3:1995+A1+A2
BS EN 50366:2003
Technische specificaties m.b.t. de constructie van deze machines worden bewaard bij de fabrikant onder de verantwoordelijkheid van hieronder vermelde persoon:
Naam: Ailyn Boyes **Functie:** Manager Technical
Ondertekend:  Datum: 20/04/2016
 Numatic International Limited, Chard, Somerset, TA20 2GB www.numatic.co.uk **NL**

CE 16
DECLARACION DE CONFORMIDAD DE LA UNIÓN EUROPEA
Declaramos bajo nuestra única responsabilidad que los siguientes equipos cumplen todas las disposiciones pertinentes de las siguientes Directivas de la UE:
Maquinaria, Directiva 2006/42/EC
EMC, Directiva 2014/30/UE
RoHS, Directiva 2011/65/UE
Descripción de la Máquina: Abrillantadoras Tipo: NPR, NR, NRL, NRT, NRS, NRU series
Fabricado por: Numatic International Limited
Normas pertinentes sobre las que se declara la conformidad, incluyen:
IEC 60335-1 2001 + A1 2004 + A2 2006 + Variantes Nacionales
IEC 60335-2:67 2002 + A1 2004
EN 55014-1:2006
EN55014-2:1997+A1
EN61000-3-2:2006
EN61000-3-3:1995+A1+A2
BS EN 50366:2003
Existe un plano de fabricación en la sede del fabricante, disponible previa autorización del abajo firmante:
Nombre: Ailyn Boyes **Cargo:** Director Técnico
Firmado:  Fecha: 20/04/2016
 Numatic International Limited, Chard, Somerset, TA20 2GB www.numatic.co.uk **ES**

CE 16
DECLARAÇÃO DE CONFORMIDADE DA UNIÃO EUROPEIA (UE)
Declaramos bajo nossa única responsabilidade que o seguinte equipamento cumpre todas as disposições constantes das seguintes diretivas técnicas da UE:
Diretivas Técnicas de Equipamentos 2006/42/EC
Diretiva Técnica EMC 2014/30/UE
Diretiva Técnica RoHS 2011/65/UE
Descrição do Equipamento: Rotativas / Enceradoras Tipo: Series NPR, NR, NRL, NRT, NRS, NRU
Manufacturado por: Numatic International Limited
Normas sobre as quais a conformidade é declarada incluem:
IEC 60335-1 2001 + A1 2004 + A2 2006 + Especificações / Especificidades Nacionais
IEC 60335-2:67 2002 + A1 2004
EN 55014-1:2006
EN55014-2:1997+A1
EN61000-3-2:2006
EN61000-3-3:1995+A1+A2
BS EN 50366:2003
No endereço do fabricante existe um arquivo de construção técnica para este equipamento, sob autorização do seguinte signatário:
Nome: Ailyn Boyes **Cargo:** Responsável Técnico
Assinado por:  Data: 20/04/2016
 Numatic International Limited, Chard, Somerset, TA20 2GB www.numatic.co.uk **PT**

CE 16
EU-SAMSVARERKLÆRING
Vi erklærer herved under vårt fulle og hele ansvar at følgende utstyr overholder alle relevante forskrifter under følgende EU-direktiver:
Maskindirektiv 2006/42/EF
EMC-direktiv 2014/30/UE
RoHS-direktiv 2011/65/UE
Beskrivelse av maskinen: Gulvmaskiner
Type: NPR, NR, NRL, NRT, NRS, NRU series
Tilrirket av: Numatic International Limited
Relevante standarder som avgjør overholdelse omfatter:
IEC 60335-1 2001 + A1 2004 + A2 2006 + Nasjonale avvik
IEC 60335-2:67 2002 + A1 2004
EN 55014-1:2006
EN55014-2:1997+A1
EN61000-3-2:2006
EN61000-3-3:1995+A1+A2
BS EN 50366:2003
En teknisk konstruksjonsfil for dette utstyret finnes ved produsentens adresse med autorisasjon fra følgende undertekst:
Navn: Ailyn Boyes **Plassering:** Teknologileder
Underskrift:  Date: 20/04/2016
 Numatic International Limited, Chard, Somerset, TA20 2GB www.numatic.co.uk **NO**

CE 16
EG-Försäkran
Vi intygar härmed under eget ansvar att följande utrustning uppfyller alla relevanta bestämmelser i följande EU-direktiv:
Maskindirektiv 2006/42/EC
EMC-Direktiv 2014/30/UE
RoHS-Direktiv 2011/65/UE
Maskinbeskrivning: Gulvmaskin
Model: NPR, NR, NRL, NRT, NRS, NRU serierna
Tillverkad av: Numatic International Limited
Relevanta standarder som EG-Försäkran baseras på inkluderar:
IEC 60335-1 2001 + A1 2004 + A2 2006 + Nationella avvikelser
IEC 60335-2:67 2002 + A1 2004
EN 55014-1:2006
EN55014-2:1997+A1
EN61000-3-2:2006
EN61000-3-3:1995+A1+A2
BS EN 50366:2003
Teknisk konstruktionsunderlag för den här utrustningen behålls på tillverkarens adress och intygas av undertecknad med signatur:
Namn: Ailyn Boyes **Befattning:** Teknisk Chef
Undertecknad:  Datum: 20/04/2016
 Numatic International Limited, Chard, Somerset, TA20 2GB www.numatic.co.uk **SE**

CE 16
ΔΗΛΩΣΗ ΣΥΜΜΟΡΦΩΣΗΣ ΕΕ
Με την παρούσα δηλώνουμε με αποκλειστική δική μας ευθύνη ότι ο παρακάτω εξοπλισμός πληροί όλες τις σχετικές διατάξεις του ανακλούμενου Οδηγίου της ΕΕ:
Οδηγός 2006/42/ΕΚ σχετικά με τα μηχανήματα
Οδηγός 2014/30/ΕΥ για την προσαρμογή των νομοθεσιών των κρατών μέλων σχετικά με την ηλεκτρομαγνητική συμβατότητα (Οδηγός EMC)
Οδηγός 2011/65/ΕΕ για την περιορισμό της χρήσης ορισμένων επικίνδυνων ουσιών σε ηλεκτρικό και ηλεκτρονικό εξοπλισμό (Οδηγός RoHS)
Περιγραφή μηχανήματος: Περιτορητική μηχανή καθαρισμού επίπλων
Τύπος: Σειρές NPR, NR, NRL, NRT, NRS, NRU
Κατασκευαστής: Numatic International Limited
Η δήλωση συμμόρφωσης βασίζεται στα εξής πρότυπα:
IEC 60335-1 2001 + A1 2004 + A2 2006 + Ηλεκτρική ασφάλεια
IEC 60335-2:67 2002 + A1 2004
EN 55014-1:2006
EN55014-2:1997+A1
EN61000-3-2:2006
EN61000-3-3:1995+A1+A2
BS EN 50366:2003
Ο τεχνικός φάκελος κατασκευής του εξοπλισμού πρέπει στη διαθεσιμότητα του κατασκευαστή υπό την ευθύνη του αποκλούμενου υπογράφοντα:
Υποσηματώνω: Ailyn Boyes **Θέση:** Τεχνικός υπεύθυνος
Υπογράφω:  Ημερίνα: 20/04/2016
 Numatic International Limited, Chard, Somerset, TA20 2GB www.numatic.co.uk **GR**

CE 16
EU OVERENSSTEMMELSEERKLÆRING
Vi bekræfter hermed vores ansvar om at dette materiel opfylder alle relevante retningslinjer i henhold til EU direktiver:
Maskin direktiv 2006/42/EC
EMC direktiv 2014/30/UE
RoHS direktiv 2011/65/UE
Maskin beskrivelse: Gulvmaskine
Type: NPR, NR, NRL, NRT, NRS, NRU series
Produceret af: Numatic International Limited
Relevante standarder hvor overensstemmelseserklæring er deklareret inkluderer:
IEC 60335-1 2001 + A1 2004 + A2 2006 + Nationale afvigelser
IEC 60335-2:67 2002 + A1 2004
EN 55014-1:2006
EN55014-2:1997+A1
EN61000-3-2:2006
EN61000-3-3:1995+A1+A2
BS EN 50366:2003
På producentens adresse vil producenten opbevare de tekniske specifikationer med en tegningsberettiget underskrift fra:
Navn: Ailyn Boyes **Sillingsbetegnelse:** Teknisk chef
Underskrevet:  Data: 20/04/2016
 Numatic International Limited, Chard, Somerset, TA20 2GB www.numatic.co.uk **DK**

CE 16
DICHIARAZIONE DI CONFORMITA' UE
Si dichiara sotto la propria esclusiva responsabilità che le seguenti apparecchiature soddisfano tutte le disposizioni relative alle seguenti direttive comunitarie:
Direttiva Macchine 2006/42/CE
Direttiva EMC 2014/30/UE
Direttiva RoHS 2011/65/UE
Descrizione della macchina
Modello: serie NPR, NR, NRL, NRT, NRS, NRU Monospazzole
Prodotto da: Numatic International Limited
Norme su cui si dichiara la conformità sono:
IEC 60335-1 2001 + A1 2004 + A2 2006 + Deroghe nazionali
IEC 60335-2:67 2002 + A1 2004
EN 55014-1:2006
EN55014-2:1997+A1
EN61000-3-2:2006
EN61000-3-3:1995+A1+A2
BS EN 50366:2003
Un dossier tecnico di costruzione di questo apparecchio viene conservato presso l'indirizzo del fabbricante in base all'autorizzazione del seguente firmatario:
Nome: Ailyn Boyes **Qualifica:** Direttore tecnico
Firmato:  Data: 20/04/2016
 Numatic International Limited, Chard, Somerset, TA20 2GB www.numatic.co.uk **IT**

CE 16
EU YHDENKUKAISUUSTODISTUS
Vakuutamme omalla vastuullamme, että seuraavat laitteet täyttävät kaikki asennusvaatimukset seuraavien EU-direktiivien määräykset:
Kone-direktiivi 2006/42/EC
EMC Direktiivi 2014/30/UE
RoHS Direktiivi 2011/65/UE
Koneen kuvaus: Lattiainhoitokone
Tyyppi: NPR, NR, NRL, NRT, NRS, NRU series
Valmistaja: Numatic International Limited
Asiaa koskevat standardit, joihin vaatimuskonemuksiltaan vakuutetaan sisältävät:
IEC 60335-1 2001 + A1 2004 + A2 2006 + Kansallisia eroja
IEC 60335-2:67 2002 + A1 2004
EN 55014-1:2006
EN55014-2:1997+A1
EN61000-3-2:2006
EN61000-3-3:1995+A1+A2
BS EN 50366:2003
Tämän laitteen tekninen rakennuskuvaus säilytetään valmistajan osastoissa allekirjoitetun valtuutettuna:
Alekkijotus: Ailyn Boyes **Asema:** Tekninen Johtaja
Allekirjoitus:  Päivä: 20/04/2016
 Numatic International Limited, Chard, Somerset, TA20 2GB www.numatic.co.uk **FI**

CE 16
EUROPEJSKA DEKLARACJA ZGODNOŚCI
Niniejszym oświadczamy z pełną odpowiedzialnością, że wyżej wymieniony produkt spełnia wszystkie wymogi określone w poniższych dyrektywach Unii Europejskiej:
Dyrektywa Maszynowa 2006/42/EC
Dyrektywa EMC 2014/30/UE
Dyrektywa RoHS 2011/65/UE
Opis maszyny: Odkurzacz
Model: seria NPR, NR, NRL, NRT, NRS, NRU
Wyprodukowano przez: Numatic International Limited
Deklarowana zgodność obejmuje poniższe normy:
IEC 60335-1 2001 + A1 2004 + A2 2006 + Odstępstwa krajowe
IEC 60335-2:67 2002 + A1 2004
EN 55014-1:2006
EN55014-2:1997+A1
EN61000-3-2:2006
EN61000-3-3:1995+A1+A2
BS EN 50366:2003
Dokumentacja techniczna dotycząca wymienionego produktu jest przechowywana przez producenta za uwzględnieniem:
Imię i Nazwisko: Ailyn Boyes **Stanowisko:** Kierownik Techniczny
Podpis:  Data: 20/04/2016
 Numatic International Limited, Chard, Somerset, TA20 2GB www.numatic.co.uk **PL**

CE 16
DECLARAȚIE DE CONFORMITATE UE
Declarăm prin prezenta pe proprie răspundere că următoarele echipamente îndeplinesc toate dispozitiile relevante ale directivelor UE de mai jos:
Directiva 2006/42/CE privind echipamentele tehnice
Directiva 2014/30/UE privind compatibilitatea electromagnetică
Directiva 2011/65/UE privind restricțiile de utilizare a anumitor substanțe periculoase în echipamentele electrice și electronice
Descrierea echipamentului: Echipamente pentru podole
Tip: seriile NPR, NR, NRL, NRT, NRS, NRU
Fabricate de: Numatic International Limited
Standardele relevante pe baza cărora este declarată conformitatea includ:
IEC 60335-1 2001 + A1 2004 + A2 2006 + Abateri naționale
IEC 60335-2:67 2002 + A1 2004
EN 55014-1:2006
EN55014-2:1997+A1
EN61000-3-2:2006
EN61000-3-3:1995+A1+A2
BS EN 50366:2003
Un dosar de construcție tehnică pentru acest echipament este păstrat la adresa producătorului sub autorizarea următorului semnatar:
Nume: Ailyn Boyes **Funcție:** Director tehnic
Semnatura:  Data: 20/04/2016
 Numatic International Limited, Chard, Somerset, TA20 2GB www.numatic.co.uk **RO**

CE 16
EL VASTAVUSDEKLARATSIIOON
Käesolevaga kinnitame ja kanname vastutust selle eest, et alljärgnevad tooted vastavad kõigile EL direktiivide sätetele.
Masinate Direktiiv 2006/42/EC
EMC Direktiiv 2014/30/UE
RoHS Direktiiv 2011/65/UE
Masina kirjeldus: Põrandahoidusmasinad
Tüüp: NPR, NR, NRL, NRT, NRS, NRU seeria
Tooja: Numatic International Limited
Deklareerivate standardite vastavust käsitleb:
IEC 60335-1 2001 + A1 2004 + A2 2006 + Riiklikud erisused
IEC 60335-2:67 2002 + A1 2004
EN 55014-1:2006
EN55014-2:1997+A1
EN61000-3-2:2006
EN61000-3-3:1995+A1+A2
BS EN 50366:2003
Selle masina tehniline dokumentatsioon on tootja nimel ja loasel kinnitatud järgneva allkirjaga:
Nimi: Ailyn Boyes **Ametikoht:** Tehniline juht
Allkirj:  Kuupäev: 20/04/2016
 Numatic International Limited, Chard, Somerset, TA20 2GB www.numatic.co.uk **EE**

CE 16
PROHLÁŠENÍ O SHODĚNÍ O
Prohlášíme na svou výlučnou odpovědnost, že následující zařízení splňuje veškeré relevantní ustanovení těchto směrnic EU:
Směrnice 2006/42/ES pro strojní zařízení
Směrnice 2014/30/UE o elektromagnetické kompatibilitě
Směrnice RoHS 2011/65/UE
Popis zařízení: Podlahové stroje
Typ: řada NPR, NR, NRL, NRT, NRS, NRU
Vyrobce: Numatic International Limited
Normy, podle nichž je shoda deklarována:
IEC 60335-1 2001 + A1 2004 + A2 2006 + Odchyly v jednotlivých zemích
IEC 60335-2:67 2002 + A1 2004
EN 55014-1:2006
EN55014-2:1997+A1
EN61000-3-2:2006
EN61000-3-3:1995+A1+A2
BS EN 50366:2003
Technická konstrukční dokumentace pro toto zařízení je uložena na adrese výrobce, a to na základě povolení následujícího osobou:
Jméno: Ailyn Boyes **Funkce:** Technický ředitel
Podpis:  Datum: 20/04/2016
 Numatic International Limited, Chard, Somerset, TA20 2GB www.numatic.co.uk **CZ**

CE 16
EU MEGFELELŐSÉGI NYILATKOZÁS
 Ezzel a közlőlapon felelősségi körünkben kijelentjük, hogy a következő készülék megfelel a következő EU irányelvek összes hatályos rendelkezésének:
 A gépektről szóló 2006/42/EK irányelv
 Az elektromágneses összeférhetőségi vonatkozó 2014/30/EU irányelv
 Az Európai Parlament és a Tanács 2011/65/EU irányelve (RoHS)

A gép megnevezése: Padlópolító gépek
Típus: NPR, NR, NRL, NRT, NRS, NRU sorozat

Gyártó: Numatic International Limited

Vonatkozó szabványok, melyek alapján a megfelelőséget kinyilvánították:
 IEC 60335-1 2001 + A1 2004 + A2 2006 + Nemzeti eltérések
 IEC 60335-2-67 2002 + A1 2004
 EN 55014-1:2006
 EN55014-2:1997+A1
 EN61000-3-2:2006
 EN61000-3-3:1995+A1+A2
 BS EN 50366:2003

A készülékhez műszaki dokumentáció áll rendelkezésre a gyártó címen, a következő alálór engedélyezése alapján:
Név: Ailyn Boyes **Beosztás:** Műszaki igazgató
Aláírás: **Datum:** 20/04/2016

Numatic International Limited,
 Chard, Somerset,
 TA20 2GB
 www.numatic.co.uk **HU**

CE 16
ДЕКЛАРАЦИЯ ЗА СЪОТВЕТСТВИЕ С ИЗИСКВАНИЯТА НА ЕС
 С настоящата декларация под наша собствена отговорност, че следното оборудване удовлетворява всички приложими изисквания на следните директиви на ЕС:
 Директива за машини 2006/42/ЕО
 Директива за електромагнитна съвместимост 2014/30/ЕУ
 Директива за ограничаване на опасните вещества 2011/65/ЕС

Описание на машината: Машини за почистване на подове
Тип: Сорени NPR, NR, NRL, NRT, NRS, NRU
Произведена от: Numatic International Limited

Приложимите стандарти, на база на които се декларира съответствието, включват:
 IEC 60335-1 2001 + A1 2004 + A2 2006 + Отклонения от национални стандарти
 IEC 60335-2-67 2002 + A1 2004
 EN 55014-1:2006
 EN55014-2:1997+A1
 EN61000-3-2:2006
 EN61000-3-3:1995+A1+A2
 BS EN 50366:2003

Файл за техническата конструкция на това оборудване се съхранява на адреса на адресанта под пълномощието на следното длъжностно лице:
Име: Ailyn Boyes **Длъжност:** Технически мениджър
Подпис: **Дата:** 20/04/2016

Numatic International Limited,
 Chard, Somerset,
 TA20 2GB
 www.numatic.co.uk **BG**

CE 16
ES ATIKTIKTES DEKLARACIJA
 Prisišindami visą atsakomybę šiuo dokumentu pareiškiame, kad toliau nurodyta įranga atitinka šią ES direktyvų nuostatas:
 Masinų direktyva 2006/42/EB
 EMS direktyva 2014/30/EU
 Pavojingų medžiagų naudojimo apribojimo direktyva 2011/65/ES

Prietaiso aprašymas: Grindų plovimo įrenginiai
Tipas: NPR, NR, NRL, NRT, NRS, NRU serija

Gamintojas: Numatic International Limited

Susiję standartai, kuriais remiantis buvo deklaruota atitikties:
 IEC 60335-1 2001 + A1 2004 + A2 2006 + Nacionaliniai nuokrypiai
 IEC 60335-2-67 2002 + A1 2004
 EN 55014-1:2006
 EN55014-2:1997+A1
 EN61000-3-2:2006
 EN61000-3-3:1995+A1+A2
 BS EN 50366:2003

Šios įrangos techninę gamybos bylą galima saugoti pas gamintoją, leidus šiam pasirašiusiajam asmeniui:
Vardas, pavardė: Ailyn Boyes **Pareigos:** Techninės priežiūros vadovas
Pasirašė: **Дата:** 20/04/2016

Numatic International Limited,
 Chard, Somerset,
 TA20 2GB
 www.numatic.co.uk **LT**

CE 16
DEKLARACIJA EU O SKLADNOSTI
 Izjavljamo pod izključno odgovornostjo, da je naslednja oprema skladna z vsemi ustreznimi določbami naslednjih direktiv EU:
 Direktiva 2006/42/ES o strojih,
 Direktiva 2014/30/EU o elektromagnetni združljivosti,
 Direktiva 2011/65/EU o omejevanju uporabe nevarnih nevarnih snovi v elektrinski in elektronski opremi.

Opis aparata: Aparati za čiščenje tal
Vrsta: seriji NPR, NR, NRL, NRT, NRS, NRU

Proizvajalec: Numatic International Limited

Ustrežni standardi, na katerih temelji izjava o skladnosti, obsegajo:
 IEC 60335-1 2001 + A1 2004 + A2 2006 + Nacionalna odstopanja
 IEC 60335-2-67 2002 + A1 2004
 EN 55014-1:2006
 EN55014-2:1997+A1
 EN61000-3-2:2006
 EN61000-3-3:1995+A1+A2
 BS EN 50366:2003

Tehnična konstrukcijska mapa za to opremo se hrani na naslovu proizvajalca, zanj pa je zadolžen naslednji podpisnik:
Ime: Ailyn Boyes **Funkcija:** Tehnični direktor
Podpis: **Datum:** 20/04/2016

Numatic International Limited,
 Chard, Somerset,
 TA20 2GB
 www.numatic.co.uk **SI**

Floor Machines Application Chart (NU-Speed Range)

		Scarifying 4, 5, 6	Stripping 7,	Shampoo 3,	Spray Cleaning	Wet Scrubbing 2, 8, 9	Dry Buffing 1, 9	Light Spray Buff 9,	Low Gloss Polish 1,	Medium Gloss Polish 1, 9	High Speed Gloss Polish 9,	Extra High Gloss Polish Burnish
NRT 1530HD	1000W				●	●			●			
	150RPM											
	1250W						●	●		●		
	300RPM											
NR-1500S	1500W	●	●	●	●	●			●			
	150RPM											
NR-1500M	1500W		●	●		●			●			
	230RPM											
NR-1500H	1500W					●		●	●			
	300RPM											
NRS-450	1500W				●		●	●		●	●	
	450RPM											
NRU-1500	1500W	Pad Size 400mm Ultra High Speed Pads Only									◆	◆
	1500RPM											

Pad Size 400mm Ultra High Speed Pads Only

Numatic Brush Description

- 1) Union Mix Polishing Brush FMA-606102, FMA-606202, FMA-606702 (Bristles Brown).
 - 2) Polypropylene Scrubbing Brush FMA-606105, FMA-606203, FMA-606703 (Outer Bristles Green).
 - 3) Nylon Wet Shampoo Brush FMA-606108, FMA-606204, FMA-606704 (All Bristles White).
 - 4) Scarifying Wire Brush FMA-606114, FMA-606706 Floor Preparation
 - 5) Three Head Silicon Carbide Grinding Discs FMA-606208 Floor Preparation
 - 6) Spirotex FMA-606211 Six Head Heavy Duty Scarifying Brush Floor Preparation
- Floortec Padless Brush System (Colour Coded Centre Bristles)**
- 7) Black Centre Coded, Heavy Duty Scrubbing And Stripping FMA-606301/FT400-1, FMA-606305/FT450-1, FMA-606315/FT500-1.
 - 8) Green Centre Coded, All Purpose General Scrubbing Brush FMA-606302/FT400-2, FMA-606306/FT450-2, FMA-606316/FT500-2.
 - 9) Red Centre Coded, Light Scrubbing When Wet, General polishing When Dry FMA-606303/FT400-3, FMA-606307/FT450-3, FMA-606317/FT500-3.

NOTE:
 10Kg & 20Kg Weight, use only on **standard speed** machines for wet/dry scrubbing, vitrification and crystallisation.
WARNING. FMA-606056 vacuum kits are for dry pick up only **DO NOT** use on wet surfaces.

IMPORTANT
 Only use the socket outlet on the appliance for Numatic recommended products.



Model	Motor	Speed	Optional Vacuum	Brush	Pad	Range	Weight	Sound Pressure dB(A)@1.7M	HAV M/S ²	Dimensions
NR-1500S	1500W	150rpm	NTD130	450mm	400mm	32m	40Kg	68.1	1.1	1250x580x460mm
NR-1500M	1500W	230rpm	NTD130	450mm	400mm	32m	40Kg	69.4	0.8	1250x580x460mm
NR-1500H	1500W	300rpm	NTD130	450mm	400mm	32m	40Kg	70.4	1	1250x580x460mm
NRL-1500	1500W	150rpm	NTD130	550mm	500mm	32m	40Kg	70.2	1.1	1250x610x540mm
NRT-1530	1000W/1250W	150/300rpm	NTD130	450mm	400mm	32m	40Kg	69.2	1.92	1250x580x460mm
NRS-450	1500W	450rpm	NTD130	450mm	400mm	32m	35Kg	68.4	1.58	1250x580x460mm
NRU-1500	1500W	1500rpm	NTD130		400mm	32m	35Kg	64.8	1.84	1250x660x460mm

HAV = Hand Arm Vibration

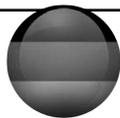

Modell	Motor	Drehzahl	Absaugung (optional)	Bürste	Pad	Arbeitsradius	Gewicht	Schalldruckpegel dB(A)@1.7M	HAV M/S ²	Abmessungen
NR-1500S	1500W	150rpm	NTD130	450mm	400mm	32m	40Kg	68.1	1.1	1250x580x460mm
NR-1500M	1500W	230rpm	NTD130	450mm	400mm	32m	40Kg	69.4	0.8	1250x580x460mm
NR-1500H	1500W	300rpm	NTD130	450mm	400mm	32m	40Kg	70.4	1	1250x580x460mm
NRL-1500	1500W	150rpm	NTD130	550mm	500mm	32m	40Kg	70.2	1.1	1250x610x540mm
NRT-1530	1000W/1250W	150/300rpm	NTD130	450mm	400mm	32m	40Kg	69.2	1.92	1250x580x460mm
NRS-450	1500W	450rpm	NTD130	450mm	400mm	32m	35Kg	68.4	1.58	1250x580x460mm
NRU-1500	1500W	1500rpm	NTD130		400mm	32m	35Kg	64.8	1.84	1250x660x460mm

HAV = Hand-/Armvibration



Model	Moteur	VITESSE	SYSTÈME D'EXTRACTION (EN OPTION)	Brosse	Disque	RAYON DE TRAVAIL	Poids	Niveau de pression sonore dB(A)@1.7M	HAV M/S ²	Dimensions
NR-1500S	1500W	150rpm	NTD130	450mm	400mm	32m	40Kg	68.1	1.1	1250x580x460mm
NR-1500M	1500W	230rpm	NTD130	450mm	400mm	32m	40Kg	69.4	0.8	1250x580x460mm
NR-1500H	1500W	300rpm	NTD130	450mm	400mm	32m	40Kg	70.4	1	1250x580x460mm
NRL-1500	1500W	150rpm	NTD130	550mm	500mm	32m	40Kg	70.2	1.1	1250x610x540mm
NRT-1530	1000W/1250W	150/300rpm	NTD130	450mm	400mm	32m	40Kg	69.2	1.92	1250x580x460mm
NRS-450	1500W	450rpm	NTD130	450mm	400mm	32m	35Kg	68.4	1.58	1250x580x460mm
NRU-1500	1500W	1500rpm	NTD130		400mm	32m	35Kg	64.8	1.84	1250x660x460mm

HAV = Mesure des vibrations main-bras



Model	Motorkop	Toeren	Optionele afzuiging	Borstel	Pad	Bereik	Gwicht	Geluidsdruk dB(A)@1.7M	HAV M/S ²	Afmeting
NR-1500S	1500W	150rpm	NTD130	450mm	400mm	32m	40Kg	68.1	1.1	1250x580x460mm
NR-1500M	1500W	230rpm	NTD130	450mm	400mm	32m	40Kg	69.4	0.8	1250x580x460mm
NR-1500H	1500W	300rpm	NTD130	450mm	400mm	32m	40Kg	70.4	1	1250x580x460mm
NRL-1500	1500W	150rpm	NTD130	550mm	500mm	32m	40Kg	70.2	1.1	1250x610x540mm
NRT-1530	1000W/1250W	150/300rpm	NTD130	450mm	400mm	32m	40Kg	69.2	1.92	1250x580x460mm
NRS-450	1500W	450rpm	NTD130	450mm	400mm	32m	35Kg	68.4	1.58	1250x580x460mm
NRU-1500	1500W	1500rpm	NTD130		400mm	32m	35Kg	64.8	1.84	1250x660x460mm

HAV = Trilling hand / arm

FLOOR MACHINE HAZARDOUS REGULATION INFORMATION.



Under certain uses, this machine may be subject to the Provision and Use of Work Equipment Regulations (council directive 89/655/EEC), Control of Substances Hazardous to Health Regulations, Dangerous Substances and Explosive Atmospheres Regulations and other Safety Regulations (council directive 98/24/EC & 99/92/EC). User must ensure that their use of this machine for any purpose meets these requirements.
Regular inspection and maintenance of this machine in accordance with the manufacturer's recommendations and the above Regulations is essential for its functional and safe operation.



Bei bestimmten Einsätzen unterliegt diese Maschine möglicherweise der Arbeitsmittel-Benutzungsrichtlinie (Richtlinie 89/655/EEC des Rates), der Richtlinie zum Schutz von Gesundheit und Sicherheit der Arbeitnehmer vor der Gefährdung durch chemische Arbeitsstoffe bei der Arbeit, der ATEX-Betreiberrichtlinie für Explosionsschutz und anderen Sicherheitsrichtlinien (Richtlinie 98/24/EG & 99/92/EG des Rates). Der Benutzer muss sicherstellen, dass der Einsatz dieser Maschine für jeden Zweck diese Anforderungen erfüllt.
Für den einwandfreien und sicheren Betrieb dieser Maschine ist ihre regelmäßige Inspektion und Wartung in Übereinstimmung mit den Herstellerhinweisen und den o. g. Richtlinien von grundlegender Bedeutung.



Pour certaines utilisations, cette machine pourra être soumise aux réglementations suivantes : Directive 89/655/CEE du Conseil concernant les prescriptions minimales de sécurité et de santé pour l'utilisation par les travailleurs au travail d'équipements de travail
"Provision and Use of Work Equipment Regulations".

-Directives 98/24/CE et 99/92/CE du Conseil du Conseil concernant la protection de la santé et de la sécurité des travailleurs contre les risques liés à des agents chimiques sur le lieu de travail et autres réglementations concernant la sécurité "Control of Substances Hazardous to Health Regulations, Dangerous Substances and Explosive Atmospheres Regulations and other Safety Regulations".

Les utilisateurs doivent s'assurer que leur usage de cette machine pour une application quelconque soit bien conforme à ces exigences.

Afin que cette machine fonctionne correctement et en toute sécurité, il est essentiel qu'elle soit périodiquement contrôlée et entretenue conformément aux recommandations du constructeur et aux Réglementations ci-dessus.



In zekere gebruiksomstandigheden, zijn de Europese Arbeidsmiddelenrichtlijn (Europese richtlijn 89/655/EEC), de richtlijnen voor de beheersing van gevaarlijke stoffen, gevaarlijke stoffen en explosieve omgevingen en andere dergelijke veiligheidsnormen (Europese richtlijnen 98/24/EC & 99/92/EC) van toepassing op deze machine. De gebruiker dient dus zeker te stellen dat de wijze waarop deze machine wordt gebruikt voor welk doel dan ook steeds aan deze veiligheidsnormen voldoet.

Deze machine dient regelmatig te worden gecontroleerd en onderhouden overeenkomstig de aanbevelingen van de fabrikant en de bovenstaande reglementen dienen nauwgezet te worden nageleefd voor een optimale en



1



2



3



4



5



6



7

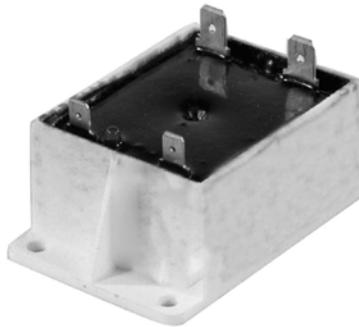

8



9



10



11



12



13



14



15

Spare Parts



		NR1500 S/M/H	NRT 1530	NRU 1500	NRS 450	NRL 1500
1	MOTOR					
	4 pole / 220 - 240v 50Hz	205217	205217			205217
	4 pole / 220 - 240v 50Hz (NO SEAL)			205218		
	4 pole / 220 - 60Hz	205219	205219			205219
	2 pole / 220 - 240v 50Hz				205222	
	2/4 pole / 220 - 240v 50Hz		205223			
2	GEARBOX					
		230206 / S	230206			230206
		230210 / M			230210	
		230209 / H				
3	230V RELAY	206575	206575	206575	206575	206575
4	12v DC FAN	205072	205072	205072	205072	205072
5	START CAPACITOR	208265	208265	208265	208265	208265
6	RUN CAPACITOR	220876	220876	220876	220876	220876
7	VOLTAGE RELAY					
	SINGLE SPEED	206823		206823	206823	206823
	TWO SPEED		206824			
8	UNIVERSAL POWER SUPPLY	206753	206753	206753	206753	206753
9	SOCKET	220964	220964	220964	220964	220964
10	HI LO SWITCH		229465			
11	WHEEL KIT	304267	304267	304268	304267	304267
12	HANDLE SWITCH	229454	229454	229454	229454	229454
13	CABLE					
	UK	236072	236072	236072	236072	236072
	EUROPEAN	236136	236136	236136	236136	236136
	SWISS	236078	236078	236078	236078	236078
	S/A	236081	236081	236081	236081	236081
	AUSTRALIAN	236087	236087	236087	236087	236087
14	HANDLE	577445	577445	577445	577445	577445
15	DECK	606361	606361	329369	606361	606362



Ersatzteile

		NR1500 S/M/H	NRT 1530	NRU 1500	NRS 450	NRL 1500
1	MOTOR					
	4 pole / 220 - 240v 50Hz	205217	205217			205217
	4 pole / 220 - 240v 50Hz OHNE FASE			205218		
	4 pole / 220 - 60Hz	205219	205219			205219
	2 pole / 220 - 240v 50Hz				205222	
	2/4 pole / 220 - 240v 50Hz		205223			
2	GETRIEBE					
		230206 / S	230206			230206
		230210 / M			230210	
		230209 / H				
3	230V RELAIS	206575	206575	206575	206575	206575
4	12V DC LÜFTER	205072	205072	205072	205072	205072
5	ANLAUFKONDENSATOR	208265	208265	208265	208265	208265
6	BETRIEBSKONDENSATOR	220876	220876	220876	220876	220876
7	SPANNUNGSRELAIS					
	1 DREHZAHL	206823		206823	206823	206823
	2 DREHZAHL		206824			
8	UNIVERSELLER NETZAN- SCHLUSS	206753	206753	206753	206753	206753
9	STECKDOSE	220964	220964	220964	220964	220964
10	HI LO SCHALTER		229465			
11	RAD BAUSATZ	304267	304267	304268	304267	304267
12	SCHALTER	229454	229454	229454	229454	229454
13	ZULEITUNG					
	UK	236072	236072	236072	236072	236072
	EUROPÄISCH	236136	236136	236136	236136	236136
	SCHWEIZ	236078	236078	236078	236078	236078
	SÜDAFRIKA	236081	236081	236081	236081	236081
	AUSTRALIEN	236087	236087	236087	236087	236087
14	HANDGRIFF	577445	577445	577445	577445	577445
15	DECK	606361	606361	329369	606361	606362



Pièces Détachées

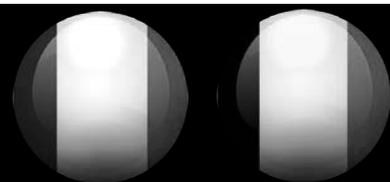

		NR1500 S/M/H	NRT 1530	NRU 1500	NRS 450	NRL 1500
1	MOTEUR					
	4 pole / 220 - 240v 50Hz	205217	205217			205217
	4 pole / 220 - 240v 50Hz SANS JOINT			205218		
	4 pole / 220 - 60Hz	205219	205219			205219
	2 pole / 220 - 240v 50Hz				205222	
	2/4 pole / 220 - 240v 50Hz		205223			
2	RÉDUCTEUR					
		230206 / S	230206			230206
		230210 / M			230210	
		230209 / H				
3	230V RELAIS	206575	206575	206575	206575	206575
4	12v DC VENTILATEUR	205072	205072	205072	205072	205072
5	CONDENSATEUR DE DÉMARRAGE	208265	208265	208265	208265	208265
6	CONDENSATEUR DE MARCHÉ	220876	220876	220876	220876	220876
7	RELAY DE TENSION					
	1 VITESSE	206823		206823	206823	206823
	2 VITESSE		206824			
8	ALIMENTATION UNIVER- SELLE	206753	206753	206753	206753	206753
9	FICHE	220964	220964	220964	220964	220964
10	HI LO CONTACT		229465			
11	ROUE KIT	304267	304267	304268	304267	304267
12	POIGNÉE CONTACT	229454	229454	229454	229454	229454
13	CÂBLE					
	UK	236072	236072	236072	236072	236072
	EUROPÉEN	236136	236136	236136	236136	236136
	SUISSE	236078	236078	236078	236078	236078
	AFRICAIN DU SUD	236081	236081	236081	236081	236081
	AUSTRALIEN	236087	236087	236087	236087	236087
14	POIGNÉE	577445	577445	577445	577445	577445
15	PONT / PLATEFORME	606361	606361	329369	606361	606362





Reserve onderdelen

		NR1500 S/M/H	NRT 1530	NRU 1500	NRS 450	NRL 1500
1	MOTOR					
	4 pole / 220 - 240v 50Hz	205217	205217			205217
	4 pole / 220 - 240v 50Hz GEEN PAKKING			205218		
	4 pole / 220 - 60Hz	205219	205219			205219
	2 pole / 220 - 240v 50Hz				205222	
	2/4 pole / 220 - 240v 50Hz		205223			
2	TANDWIELOVERBRENGING					
		230206 / S	230206			230206
		230210 / M			230210	
		230209 / H				
3	230V RELAIS	206575	206575	206575	206575	206575
4	12v DC Waaier	205072	205072	205072	205072	205072
5	START CONDENSATOR	208265	208265	208265	208265	208265
6	RUN CONDENSATOR	220876	220876	220876	220876	220876
7	RELAIS					
	1 Toeren	206823		206823	206823	206823
	2 Toeren		206824			
8	UNIVERSELESTROOMVOORZIENING	206753	206753	206753	206753	206753
9	STOPCONTACT	220964	220964	220964	220964	220964
10	HI LO SCHAKELAAR		229465			
11	WIEL KIT	304267	304267	304268	304267	304267
12	HANDEL SCHAKELAAR	229454	229454	229454	229454	229454
13	SNOER					
	GB	236072	236072	236072	236072	236072
	EUROPEES	236136	236136	236136	236136	236136
	ZWITSERLAND	236078	236078	236078	236078	236078
	ZUID AFRIKAANS	236081	236081	236081	236081	236081
	AUSTRALISCH	236087	236087	236087	236087	236087
14	HANDEL	577445	577445	577445	577445	577445
15	BORSTELHUIS	606361	606361	329369	606361	606362



NR / NRU / NRS / NRL 230V (Floor Machine)

WD-0345 (A06) 20.09.11

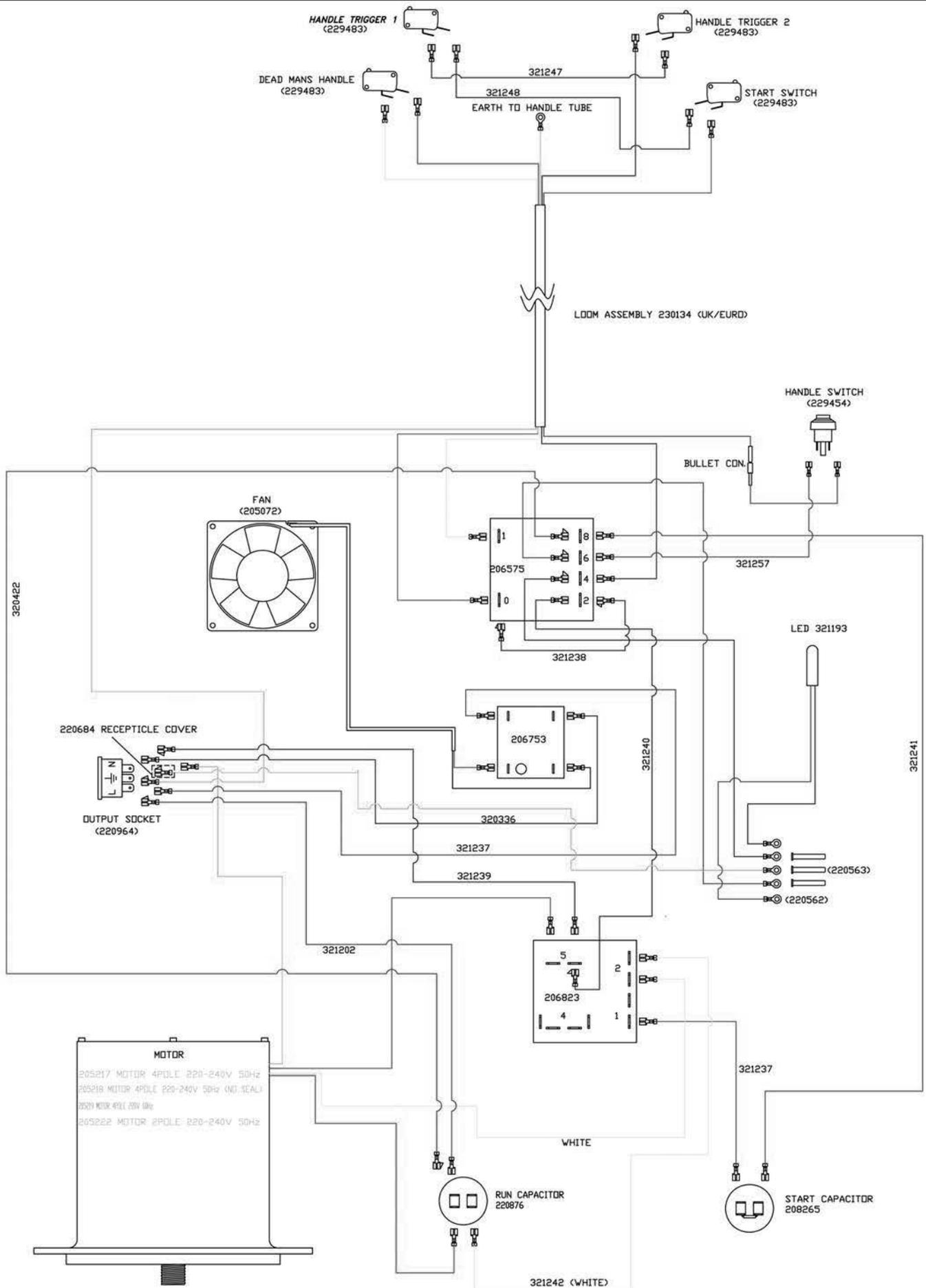

Nuspeed Accessories

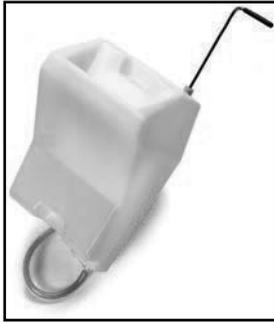

FMA- 606084 NuSpeed Solution Tank.

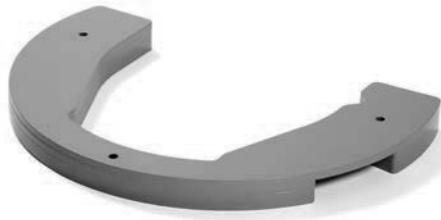

FMA-606113:- NuSpeed extra external 10Kg weight for NR 1500S (40Kg to 50Kg)



FMA-900525:- 400mm Nuloc Pad Drive Board



FMA-606054:- NR optional spraytec Kit



FMA-606202:- 450m Union Mix Polish Brush



FMA-606700:- 400m Porcupine Pad Holder



FMA-606056:- NR Dustrol Kit

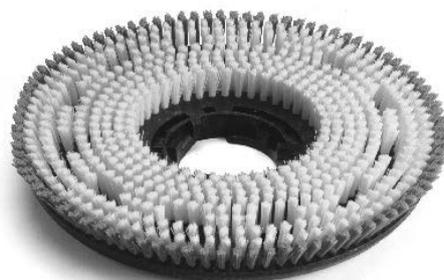

FMA-606203:- 450 Polyscrub Brush



FMA-60115:- 550mm Union mix Polish brush



FMA-606079:- NR/NPR Dustrol Control Brush Ring

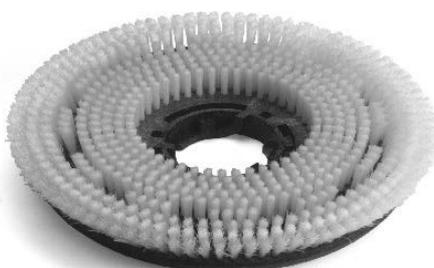

FMA-606204:- 450mm Nyloscrub Brush

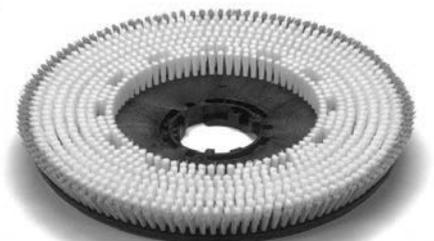

FMA-606028 550mm Polyscrub Brush

- 150rpm - 30Kg / 40Kg / 50Kg

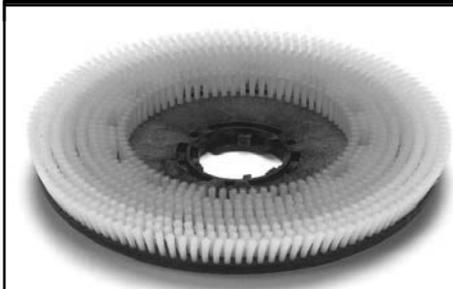

FMA-606550:-550mm Nylonscrub Brush



FMA-606307:- FT 450/3 Floortec Longlife Light Scrubbing Brush.



FMA-606208:- 400mm Carbotech Grinding Disc



FMA-900526:- 500mm Nuloc Pad Drive Board

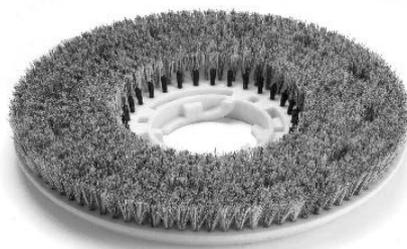

FMA-606308:- 450/4/ Floortec High Lustre Polish Brush



FMA-606209:- 400mm Sandotex Disc Drive



FMA-606305:- FT 450/1 Floortec Heavy Duty Scrubbing/ Stripping Brush



FMA-606551:- 550mm Floortec Longlife Brush



FMA-606211:- 400mm Heavy Duty Scarifying Disc - Spirotex 6 head

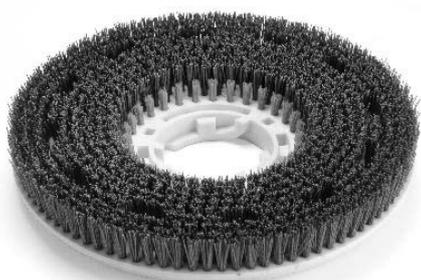

FMA-606306:- 450mm floortec Longlife Brush

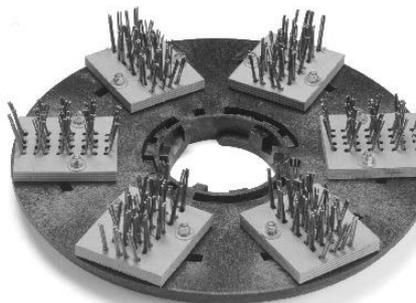

FMA-606207:- 400mm Wire Scarifying Brush



Specialised Accessories - 300rpm



FMA - 900528 Flexi - Pad Drive for use with top quality pads

Specialised Accessories - 450rpm



FMA - 606087
Spider Drive Universal High - Speed
Polishing Brush



FMA - 606078
Spider High - Speed
Pad Drive



FMA - 606086
Spider Drive
High - Speed Short Trim
Burnishing Brush



FMA - 606088
Spider Drive Floortec
High - Speed Long Life
Polishing Brush



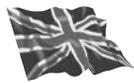

Numatic International Limited.
Chard, Somerset TA20 2GB ENGLAND
Tel: 01460 68600 www.numatic.co.uk



Numatic International GmbH. Fränkische Straße 15–19
D-30455 Hannover, DEUTSCHLAND
Tel: 05 11 98 42 16 0 www.numatic.de



Numatic International SAS. EAE La Tuilerie – 13 / 17 rue du Valengelier
77500 CHELLES, FRANCE
Tel: 01 64 72 61 61 www.numatic.fr



BeNeLux Distribution, Numatic International BV
Postbus 101, 2400 AC Alphen aan den Rijn, NEDERLAND
Tel: 0172 467 999 www.numatic.nl

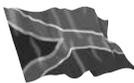

Numatic International (Pty.) Ltd.
16th & Pharmaceutical Roads, Midrand, Gauteng,
SOUTH AFRICA 1685
Tel: 0861 686 284 www.numatic.co.za



Numatic International Schweiz AG.
Sihlbruggstrasse 3A, 6340 Baar. SCHWEIZ
Tel: 0041 (0) 41 76 80 76 - 0 www.numatic.ch



Numatic International ULDA. Rua da Boa Viagem, 177
4470.210 Maia. PORTUGAL
Tel: +351 220 047 700 www.numatic.pt



Numatic International SLU. C/ La Forja, 41, 08840 Viladecans
(Barcelona), Spain
Tel: +34 93 647 22 22 www.numatic.es